

USER'S MANUAL

PDS4203W-H/PDS4203E-H

42" WIDE PLASMA DISPLAY

Plasmavision™

Contents

	Page		Page
Before Use		Adjustments	
• Safety Precautions	3-5	Video Mode	
• Features	6	• Video Adjustments	24-25
• Accessories	7	• Screen Adjustments	26-27
• What You Should Know	8-9	• Input Source Adjustments	28-29
• Preventing Equipment from Falling	10	• Other Adjustments	30-31
Usage		RGB Mode	
• Names of Parts and Their Functions	11-14	• Video Adjustments	32-33
• Basic Operations	15	• Screen Adjustments	34-35
• Viewing Wide Screen (Video Mode)	16-17	• Input Source Adjustments	36-37
• Viewing Wide Screen (RGB Mode)	18-19	• Other Adjustments	38-39
Handy Functions		Others	
• On-Screen Display Setting	20	• Personal Computers that Can be Connected	40
• Internal Speaker Setting	21	• Optional Products	41
• WHITE BALANCE Setting	22	• Specifications	42-43
• DPMS and Display Language Setting	23	• Care and Maintenance	44

Before using the display, read this manual carefully so that you know how to use the display correctly.

Refer to this manual whenever questions or problems about operation arise. Be sure to read and observe the safety precautions.

Keep this manual where the user can see it easily.

** Installation and removal require special expertise. Consult your product dealer for details*

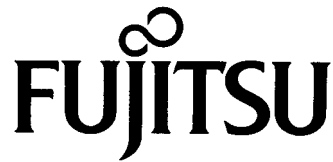

DECLARATION OF CONFORMITY

according to EN45014

We

Fujitsu General (Euro) GmbH

of

Werftstraße 20, D-40549 Düsseldorf, F. R. Germany

Manufacturer: Shinjyo Fujitsu General Limited
702-3 Kanezawa Shinjyo-shi
Yamagata Japan

declares under our sole responsibility that the product,

Type: 42" PLASMA DISPLAY

Model Name: PDS4203W-H/PDS4203E-H

to which this declaration relates are in conformity with the following standards;

European Standards:

EMC: a. EN55022 1994, Class A

b. EN61000-3-2 1995

c. EN61000-3-3 1995

d. EN50082-2 1995

(EN61000-4-2 1995 / EN 61000-4-4 1995 / EN61000-4-8 1993)

(ENV50140 1993 / ENV50141 1993 / ENV50204 1995)

Safety: e. EN60950 1992/A1:1993/A2:1993)

*By conformance with the standard referenced, the product follows
the provisions of the directives listed below.*

a. EC Council Directive 89/336/EEC of 3rd, May 1989

b. EC Council Directive 92/31/EEC of 28th, April 1992

c. EC Council Directive 93/68/EEC of 22nd, July 1993

d. EC Council Directive 73/23/EEC of 19th, February 1973

Place of Issue: Germany

Date of Issue: Nov. 1997

Signature: _____

H. Hirosaki, Managing Director
Fujitsu General (Euro) GmbH

Declaration reference: Fujitsu General (Euro) GmbH

Werftstraße 20, D-40549 Düsseldorf, F. R. Germany

Tel: 0211-50098-0 Fax: 0211-50098-50

FCC NOTICE

This equipment has been tested and found to comply with the limits for a Class A digital device, pursuant to Part 15 of the FCC Rules. These limits are designed to provide reasonable protection against harmful interference when the equipment is operated in a commercial environment. This equipment generates, uses, and can radiate radio frequency energy and, if not installed and used in accordance with the instruction manual, may cause harmful interference to radio communications. Operation of this equipment in a residential area is likely to cause harmful interference in which case the user will be required to correct the interference at his own expense.

IMPORTANT INFORMATION

WARNING: This is Class A product. In a domestic environment this product may cause radio interference in which case the user may be required to take adequate measures.

WARNING: TO REDUCE THE RISK OF FIRE AND ELECTRIC SHOCK, DO NOT EXPOSE THIS PRODUCT TO RAIN OR MOISTURE.

IMPORTANT SAFEGUARDS

Electrical energy can perform many useful functions. This unit has been engineered and manufactured to assure your personal safety. But **IMPROPER USE CAN RESULT IN POTENTIAL ELECTRICAL SHOCK OR FIRE HAZARD**. In order not to defeat the safeguards incorporated into this product, observe the following basic rules for its installation, use and service. Please read these "Important Safeguards" carefully before use.

- All the safety and operating instructions should be read before the product is operated.
- The safety and operating instructions should be retained for future reference.
- All warnings on the product and in the operating instructions should be adhered to.
- All operating instructions should be followed.
- Unplug this product from the wall outlet before cleaning. Do not use liquid cleaners or aerosol cleaners. Use a damp cloth for cleaning.
- Do not use attachments not recommended by the product manufacturer as they may be hazardous.
- Do not use this product near water. Do not use immediately after moving from a low temperature to high temperature, as this causes condensation, which may result in fire, electric shock, or other hazards.
- Do not place this product on an unstable cart, stand, or table. The product may fall, causing serious injury to a child or adult, and serious damage to the product. The product should be mounted according to the manufacturer's instructions, and should use a mount recommended by the manufacturer.
- When the product is used on a cart, care should be taken to avoid quick stops, excessive force, and uneven surfaces which may cause the product and cart to overturn, damaging equipment or causing possible injury to the operator.
- Slots and openings in the cabinet are provided for ventilation. These ensure reliable operation of the product and protect it from overheating. These openings must not be blocked or covered. (The openings should never be blocked by placing the product on bed, sofa, rug, or similar surface. It should not be placed in a built-in installation such as a bookcase or rack unless proper ventilation is provided and the manufacturer's instructions have been adhered to.)



For proper ventilation, separate the product from other equipment, which may prevent ventilation and keep distance more than 10cm.

SAFETY PRECAUTIONS

- This product should be operated only with the type of power source indicated on the label. If you are not sure of the type of power supply to your home, consult your product dealer or local power company.
- This product is equipped with a three-wire plug. This plug will fit only into a grounded power outlet. If you are unable to insert the plug into the outlet, contact your electrician to install the proper outlet. Do not defeat the safety purpose of the grounded plug.
- Power-supply cords should be routed so that they are not likely to be walked on or pinched by items placed upon or against them. Pay particular attention to cords at doors, plugs, receptacles, and the point where they exit from the product.
- For added protection of this product during a lightning storm, or when it is left unattended and unused for long periods of time, unplug it from the wall outlet and disconnect the cable system. This will prevent damage to the product due to lightning and power line surges.
- Do not overload wall outlets, extension cords, or convenience receptacles on other equipment as this can result in a risk of fire or electric shock.
- Never push objects of any kind into this product through openings as they may touch dangerous voltage points or short out parts that could result in a fire or electric shock. Never spill liquid of any kind on the product.
- Do not attempt to service this product yourself as opening or removing covers may expose you to dangerous voltages and other hazards. Refer all service to qualified service personnel.
- Unplug this product from the wall outlet and refer service to qualified service personnel under the following conditions:
 - a) When the power supply cord or plug is damaged.
 - b) If liquid has been spilled, or objects have fallen on the product.
 - c) If the product has been exposed to rain or water.
 - d) If the product does not operate normally by following the operating instructions. Adjust only those controls that are covered by the Operation Manual, as an improper adjustment of other controls may result in damage and will often require extensive work by a qualified technician to restore the product to its normal operation.
 - e) If the product has been dropped or damaged in any way.
 - f) When the product exhibits a distinct change in performance – this indicates a need for service.

- When replacement parts are required, be sure the service technician has used replacement parts specified by the manufacturer or with same characteristics as the original part. Unauthorized substitutions may result in fire, electric shock, or other hazards.
- Upon completion of any service or repairs to this product, ask the service technician to perform safety checks to determine that the product is in proper operating condition.
- The product should be placed more than one foot away from heat sources such as radiators, heat registers, stoves, and other products (including amplifiers) that produce heat.
- When connecting other products such as VCR's, and personal computers, you should turn off the power of this product for protection against electric shock.
- Do not place combustibles behind the cooling fan. For example, cloth, paper, matches, aerosol cans or gas lighters that present special hazards when over heated.
- Use only the accessory cord designed for this product to prevent shock.

The power supply voltage rating of this product is AC100-240 V, the power cord attached conforms to the following power supply voltage. Use only the power cord designated by our dealer to ensure Safety and EMC.

When it is used by other power supply voltage, power cable must be changed.

Consult your product dealer.

Power cord

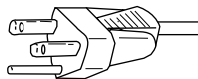

Power supply voltage: AC100-125V

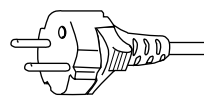

AC 200-240 V

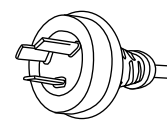

AC 240 V (SAA TYPE)

FEATURES

VERTICAL INSTALLATION

The dynamic vertical screen is obtained by installing the Plasmavision vertically.

PLASMAVISION SUPPORTS

The VGA full display and SVGA compression display suitable for personal computers

A VARIETY OF INPUT TERMINALS

The high quality image color difference signals such as DVD etc. can be input in addition to the video, S-video, and RGB.

CONVENIENT POWER MANAGEMENT FUNCTION

DPMS (Display Power Management Signaling) automatically minimizes power consumption.

FIVE TYPES OF WIDE DISPLAY

Five types of wide display are supported: WIDE 1, WIDE 2, ZOOM 1, ZOOM 2 and normal display (4:3).

ACCESSORIES

Checking Accessories

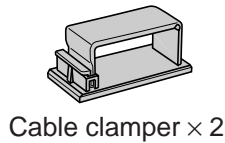

Cable clamer × 2



Power cord
PDS4203W-H × 3
PDS4203E-H × 1



Remote controller × 1

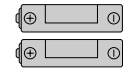

AA battery × 2



User's Manual × 1

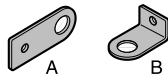

Bracket × 2 (2 type)

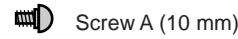

Screw A (10 mm)

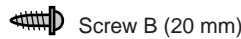

Screw B (20 mm)

Screw × 2 (2 type)

Cable clampers

- The accessory cable clampers are for fastening the connected signal cables and a power cable. When installing this display on a wall or ceiling, insert the cable clampers into the holes on the rear of the display.

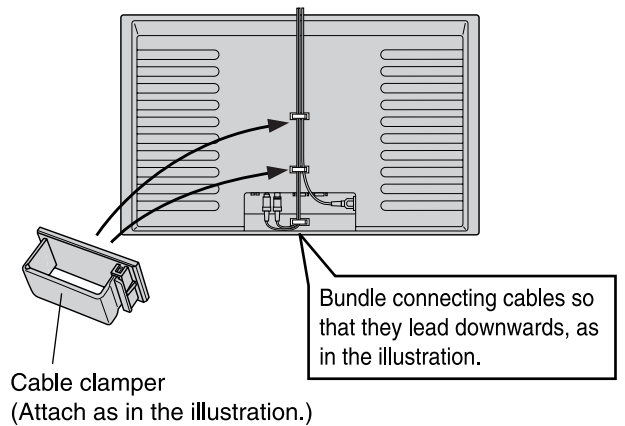

Connecting to External Equipment

Cables for connecting external equipment must be purchased separately.

Connectors	
AUDIO INPUT	Pin jack
VIDEO INPUT	BNC
S-VIDEO INPUT	S terminal
COMPONENT VIDEO INPUT	BNC
RGB INPUT	15-pin mD-sub
RS-232C	9-pin D-sub

- * When connecting separately purchased BNC terminals, conversion connectors are required between the pin jacks and the BNC terminals, so purchase these also.
- * Cables connecting the personal computer vary according to the type of machine, so consult your product dealer.

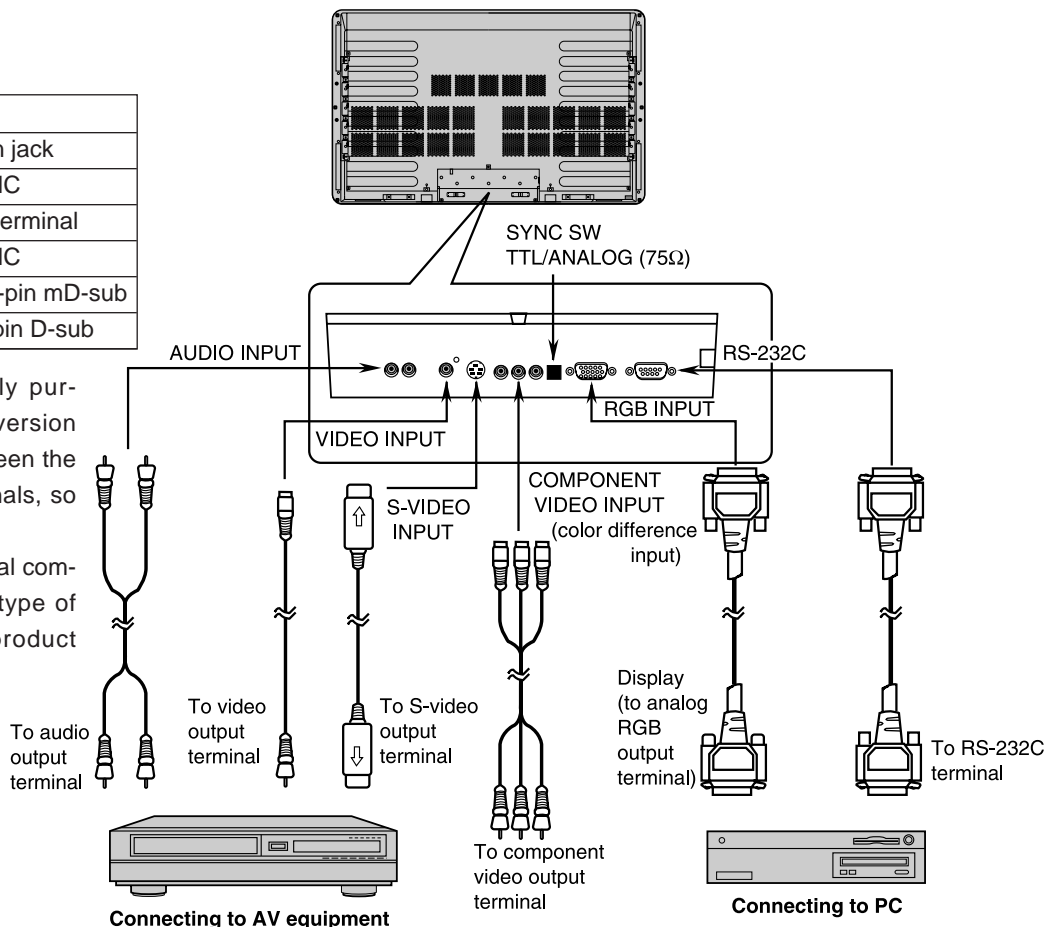

WHAT YOU SHOULD KNOW

POINTS ABOUT USAGE

- When installing the display, use the optional desktop stand, wall-mounting unit, or ceiling mounting unit. Have the installation done by your product dealer.
 - When installing the display, refer to the installation manuals for the options. Further, be sure that the display does not lean to the side or backward.
 - Place the power cord and connection cables in a corner of the wall or floor so that they do not get caught on anything
 - For good heat dissipation, the Plasmavision requires at least the space shown in the figure below.
 - The installation location must have an ambient temperature range of 0 °C – 40 °C.
- See page 41 for optional parts.

When desktop stand used

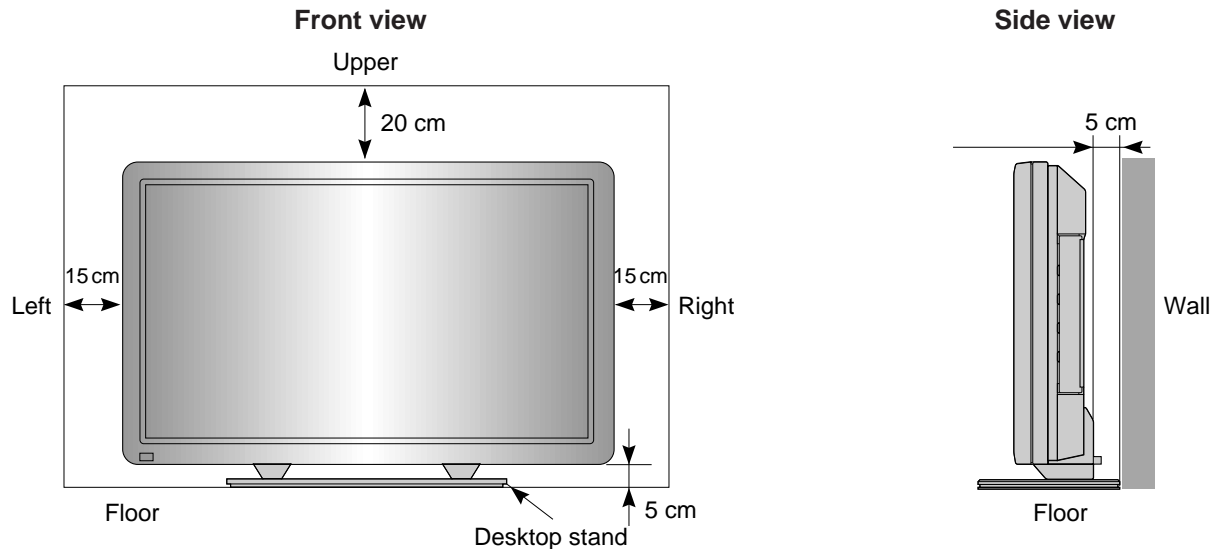

When wall-mounting unit used (horizontally)

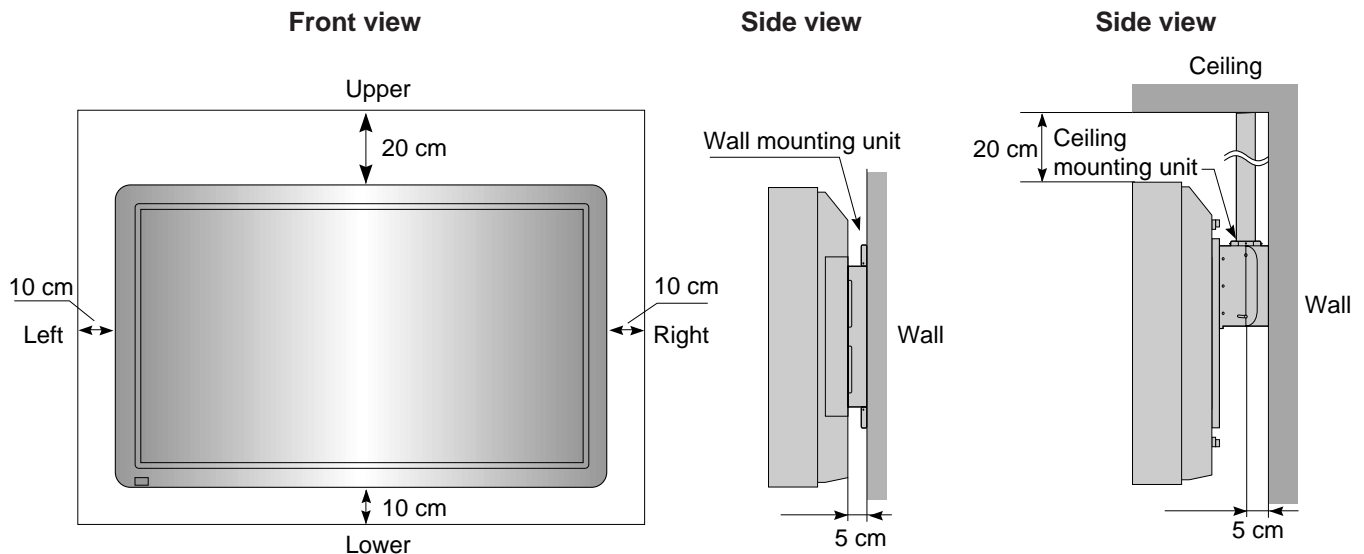

When wall-mounting unit used (vertically)

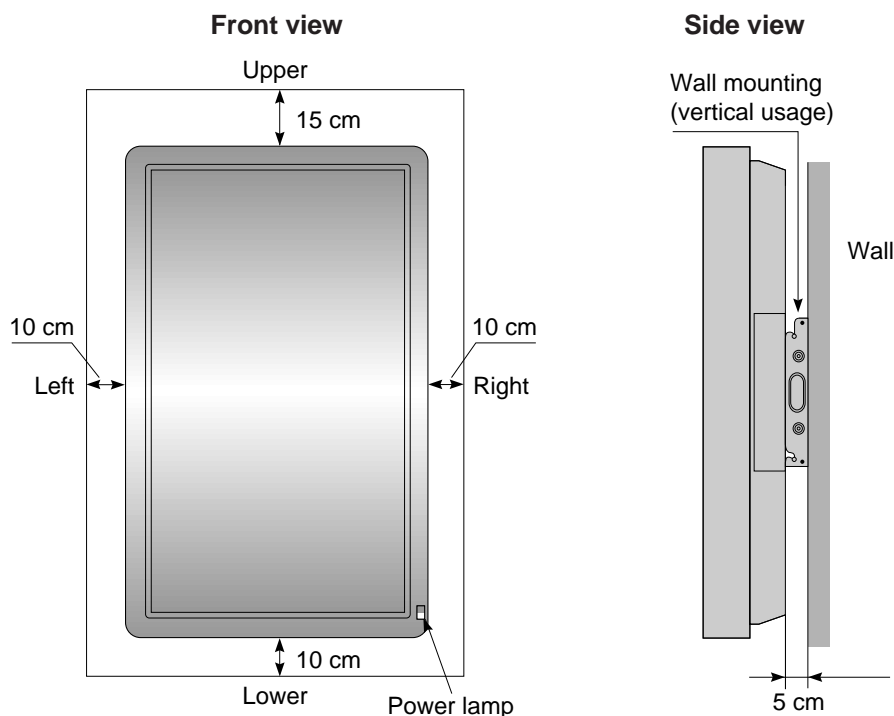

- When mounting the PlasmaVision vertically, make sure that the power lamp is at the lower right.

Notes

- Do not display the same picture (pattern) continuously for a long time. Doing so raises the brightness of the picture and may cause after-images.
- Looking at the picture continuously for a long time can tire the eyes. View the display from a reasonable distance (about three times the length of the screen).
- * If something is wrong with the PlasmaVision internally, the built-in protection circuit will cut the power automatically. If so, the power lamp will blink in red, indicating a malfunction.
- If the power lamp is blinking red, it is warning that something is wrong with the PlasmaVision. There is a danger of fire or electrical shock, so be certain to unplug the power cord and contact your product dealer. (See P44)
- The plasma display panel has been built using extremely precise and sophisticated technologies. More than 99.99% of its pixels are effective. However, a minute number of pixels are missing or constantly lit.
- Do not install the PlasmaVision where there will be interference between it and other AV equipment. (If interference from electromagnetic waves causes jumbled images, noise or malfunctioning of the infrared remote control, change the installation location.)
- When the display is installed vertically, only still images appears.

PREVENTING EQUIPMENT FROM FALLING

To prevent accidents and to ensure safety during disasters such as earthquakes, take precautions to ensure that the equipment cannot topple over.

ATTACHING TO WALL OR COLUMN

- Remove the display cover from both sides. Then, for both left and right sides, use screw A (10 mm) to attach bracket A to the screw hole (highest of the five holes on the side).
- For both left and right sides, use screw B (20 mm) to attach bracket B to the wall. Then tie brackets A and B with a strong rope so that the display panel does not topple over.
- This arrangement is stable when the rope is horizontal or pulled downward.

How to remove display cover

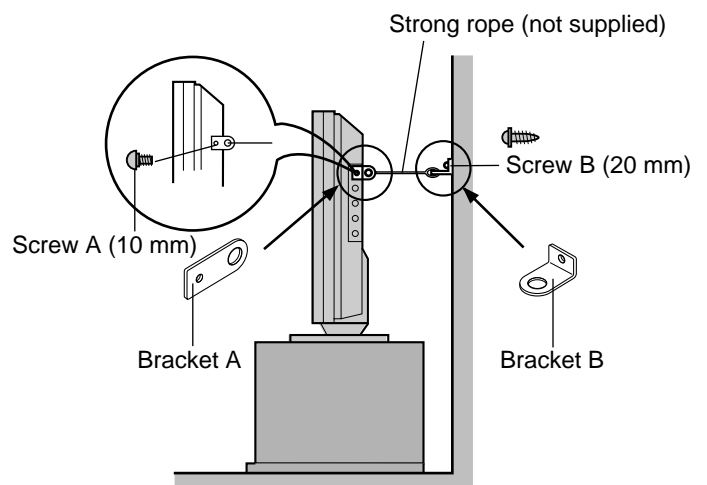
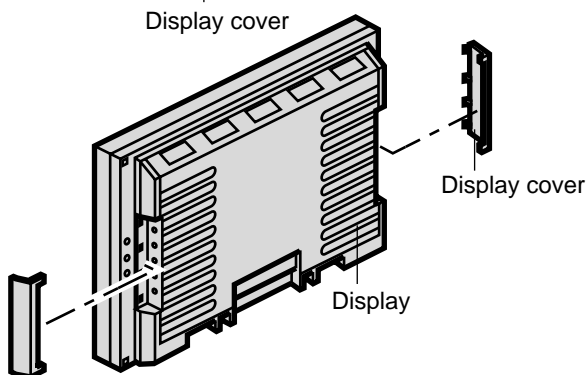
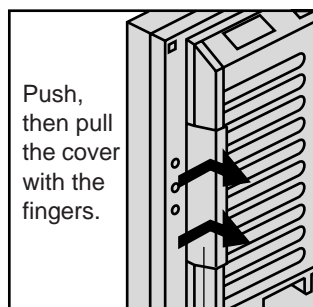

ATTACHING TO DESKTOP STAND

- Fasten the screws supplied with the desktop stand into their holes at the rear of the desktop stand. (2 holes)
- For details, refer to P-42TT01 User's Manual for the desktop stand.

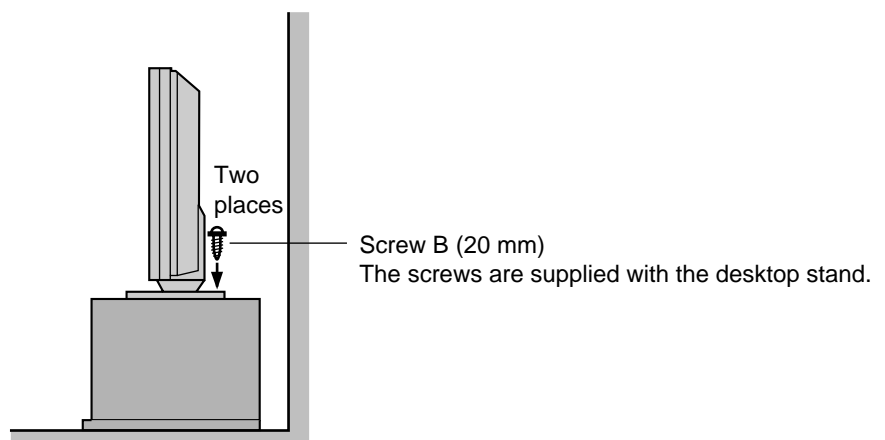

NAMES OF PARTS AND THEIR FUNCTIONS

Front view

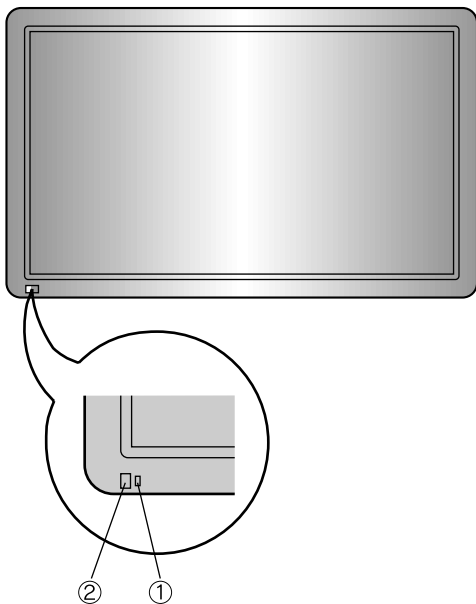

① Power lamp

- Shows the power status, ON or OFF.
- Lit (red)....Standby
- Lit (green)....Power on
- Blinking (red)....Internal abnormality. Be certain to unplug the power cord.

② Remote control receiver

- Receives the signals from the remote controller.

Bottom view

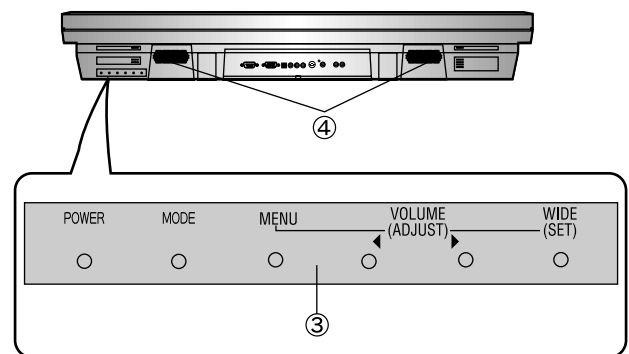

③ Operation panel

- POWER button: Switches the power on or off.
- MODE button: Selects the input mode.
- MENU button: For adjusting the video and audio to your taste.
- VOLUME (ADJUST)
◀▶ buttons: Normally used for adjusting the volume. During adjustments, these buttons are used for making adjustments from the menu screen.
- WIDE (SET) button: Normally used for selecting the desired wide screen. During adjustments, this is the (SET) button for setting the menu screen.

④ Internal speakers

- Output the audio connected to the audio input terminals.

NAMES OF PARTS AND THEIR FUNCTIONS

Rear view

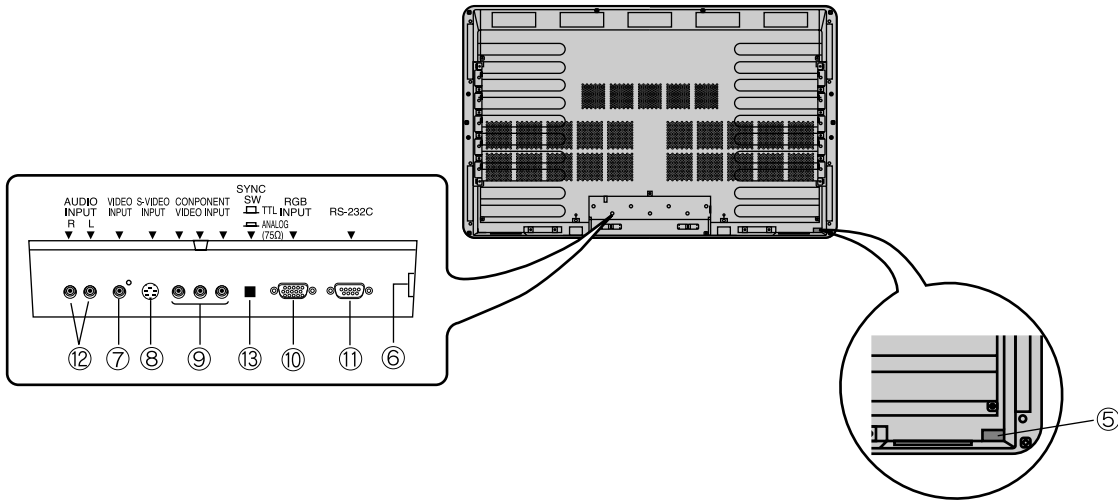

⑤ Power switch

- When pressed, power lamp ① lights red, and the power can be turned on or off by the remote controller. When this switch is pressed again, the power is cut and power lamp ① goes off.

⑥ Power input terminal

- Firmly insert the accessory power cord as far as it will go into the power input terminal.
- Firmly push the power cord plug as far as it will go into the power socket. (100–240 VAC)

⑦ Video input terminal (VIDEO INPUT)

- Connects to the video output terminal of a video deck or video disc player.

⑧ S video input terminal (S-VIDEO INPUT)

- Connects to the S video output terminal of a video deck or video disc player.

⑨ Component video input terminal (COMPONENT VIDEO INPUT)

- Connects to the component video output terminal of DVD and similar devices.

⑩ RGB input terminal (RGB INPUT)

- Connects to the computer monitor's (analog RGB) output terminal.
Cables connecting the personal computer vary according to the type of machine, so consult your product dealer.

⑪ RS-232C input terminal (RS-232C)

- Connects to the computer RS-232C output terminal.

⑫ Audio input terminals (AUDIO INPUT)

- Connects to the audio output terminal of a video deck or similar device.

⑬ Sync switch (SYNC SW TTL/ANALOG (75 Ω))

- For switching the RGB terminals' 13-pin horizontal sync and 14-pin vertical sync to terminate with 75 Ω. When an analog synchronous signal is input at the RGB terminal, be sure that this switch is set to ANALOG (75 Ω). For connection to a personal computer, be sure it is set to TTL.

A Remote controller

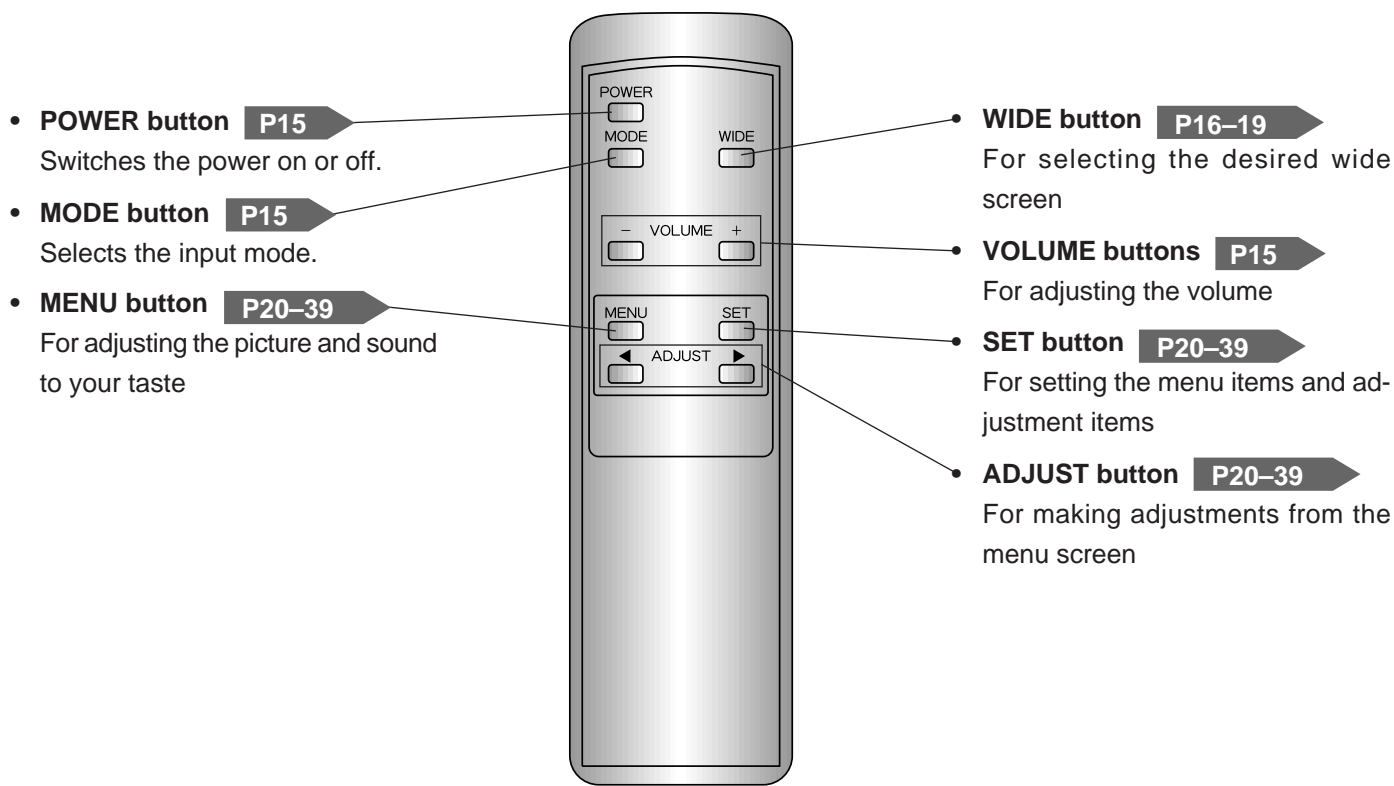

• **For the adjustment menu, see the pages below.** ➔

Handy functions (on-screen display, speaker, white balance, DPMS, language)

P20–23 ➔

VIDEO mode adjustment menu

P24–31 ➔

RGB mode adjustment menu

P32–39 ➔

Points about usage

- Do not subject the remote controller to strong mechanical shocks. Doing so can cause malfunction.
- Do not get the remote controller wet or leave it in a hot location or near any heat source such as a heater. Doing so can cause malfunction or deformation.
- Do not wipe the remote controller with volatile liquids such as benzine or paint thinner.

NAMES OF PARTS AND THEIR FUNCTIONS

Handling the remote controller

Loading the batteries

- 1** Press on the cover and slide in the direction of the arrow.
- 2** Load two AA batteries, taking care that the + and – ends face the correct direction.
- 3** Close the cover until it clicks.

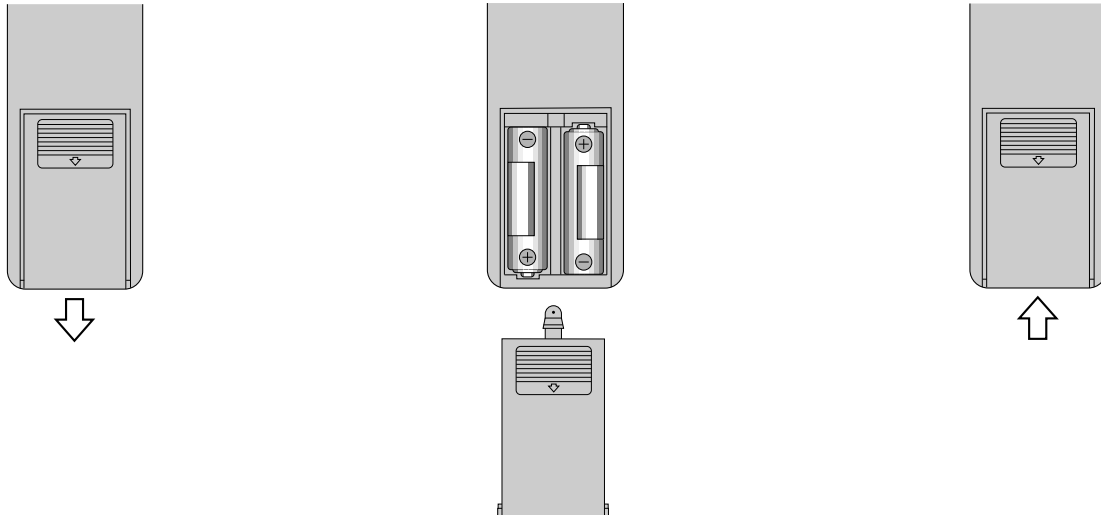

Reception range of remote controller

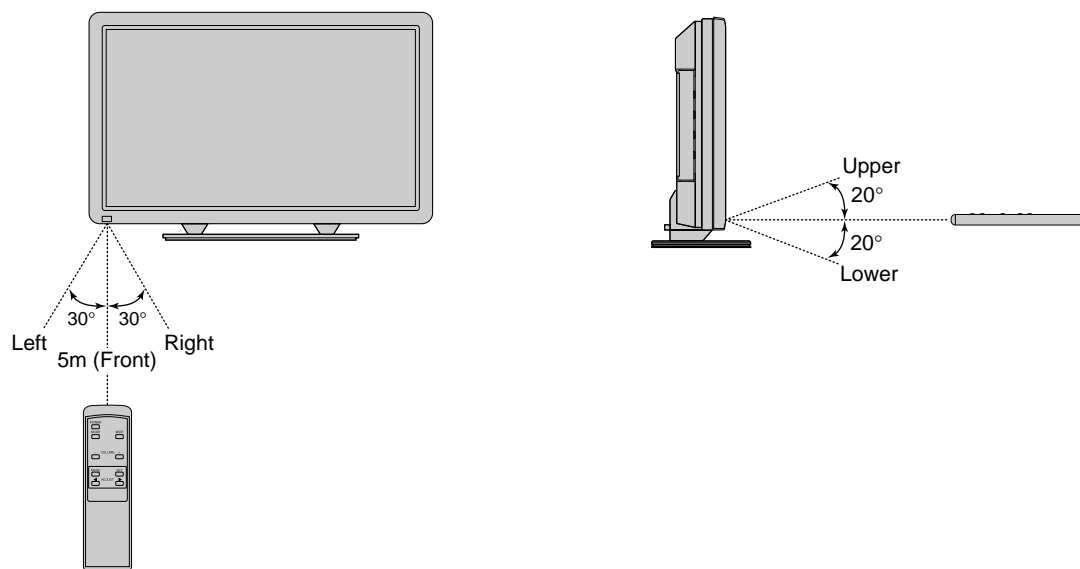

Points about usage

- Use the remote controller pointed in the direction of the remote control reception section, making sure there is no obstruction.
 - The remote controller may not operate correctly in a room using high-frequency fluorescent lights. If this happens, move away from those lights.
 - After it has been used for a long time, the remote controller batteries go flat. When this happens, replace them with new ones.
 - When replacing the batteries, make sure they are the same type as the originals.
-

BASIC OPERATIONS

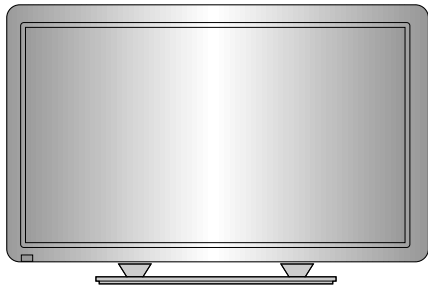

PREPARATION

Switch on the main power switch.

Press the main POWER SWITCH at the rear. The power lamp lights (red). Pressing this switch again switches off the power.

1 Press the POWER button.

The power lamp changes from red to green.



Example: VIDEO mode

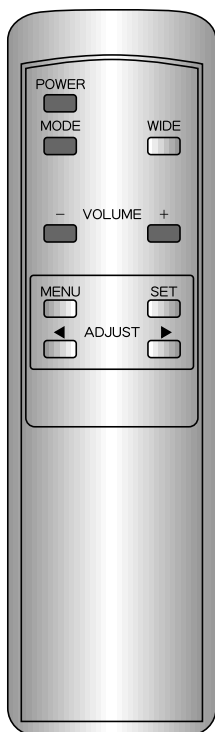

2 Select the video mode.

Select the video mode with the MODE button.

Pressing the MODE button moves the mode to the next item as below.

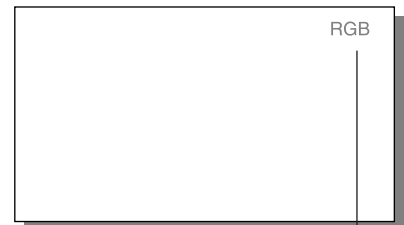
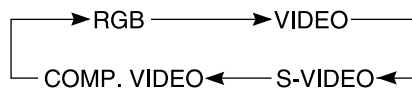

Example: When RGB selected

Mode display

* Adjusting the volume

Use the VOLUME buttons to adjust the volume .

+ button....Raises the volume.

- button....Lowers the volume.

* The current volume setting is memorized even when the power is switched off.

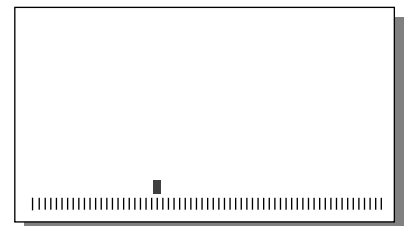

* This operation can also be done using the buttons on the Display's operation panel.

Mode display

- COMP.VIDEO stands for component video mode.
- When the speaker setting (see p.21) is OFF, SPEAKER OFF will be displayed if the VOLUME button is pressed.

VIEWING WIDE SCREEN (VIDEO MODE)

SWITCHING THE WIDE SCREEN AUTOMATICALLY

1 Press the WIDE button.

The current viewing mode is displayed.

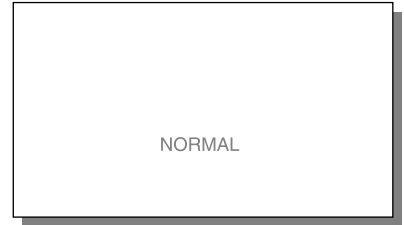

Example: NORMAL mode

2 With the WIDE button, select AUTO mode.

Pressing the WIDE button moves the mode to the next item as below.

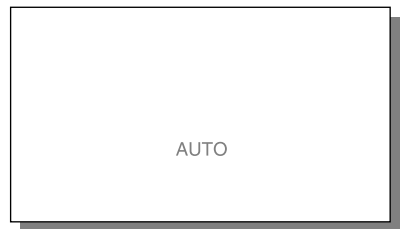
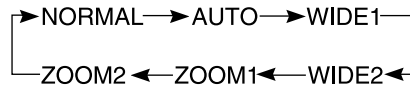

Example: When AUTO is selected,

When AUTO is selected, the wide screen is automatically selected according to the contents of the video.

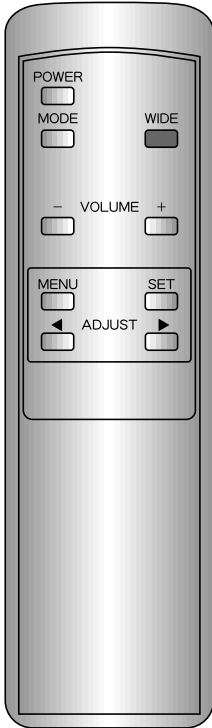

* This operation can also be done using the buttons on the Display's operation panel.

* AUTO mode cannot be selected in COMPONENT VIDEO mode.

In AUTO mode, the contents of the video software are detected and the display switches to the optimum wide screen as follows:

• WIDE 1

The appropriate wide screen for ordinary video (4:3) software

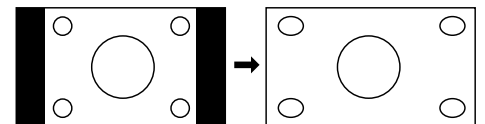

Ordinary video (4:3 video) WIDE 1

• WIDE 2

Appropriate for 16:9 video compressed to horizontally wide 4:3 video

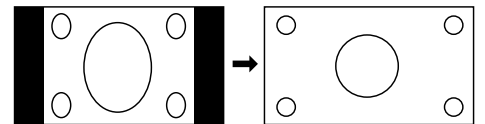

Vertically wide video WIDE 2

• ZOOM 1

Appropriate for horizontally wide video software; a normal picture appears with the top, bottom, left, and right enlarged.

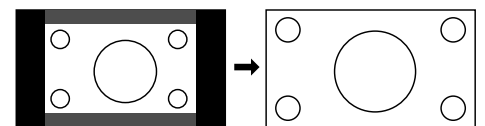

Horizontally wide video ZOOM 1

• ZOOM 2

For horizontally wide video software with subtitles, the display is automatically adjusted to compress the subtitle section so that it is not cut out.

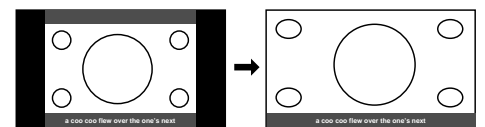

Horizontally wide video with subtitles ZOOM 2
NORMAL mode Wide screen

When AUTO mode is selected

With certain software, the Plasmavision may not operate correctly in AUTO mode. If so, use the WIDE button to switch to the most appropriate screen size.

Examples:

- Some game software will invoke the zoom screen (where the top and bottom of the screen are missing).
- For some 4:3 video software, in scenes where the top and bottom are extremely dark, the display may switch to the zoom screen.
- For video software that switches to the zoom screen automatically, the display may take a few moments to switch to the zoom screen for the first dark scene.

SETTING THE DESIRED WIDE SCREEN SIZE

1 Press the WIDE button.

The current viewing mode is displayed.

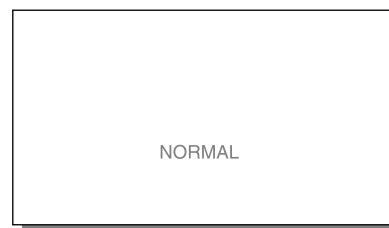

2 Use the WIDE button to select the desired screen size.

Pressing the WIDE button moves the mode to the next item as below.

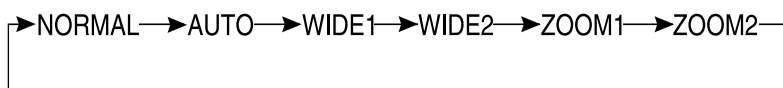

Select the wide screen size to suit the program.

*AUTO mode cannot be selected in COMPONENT VIDEO mode.



Example: When WIDE 1 is selected

SCREENS ASPECT RATIO

The aspect ratios (horizontal to vertical size ratios) for broadcasts and videos are as follows:

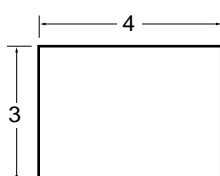

• VHF/UHF broadcasts

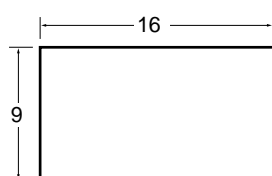

• Vistavision size software

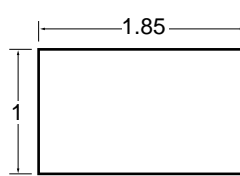

• Vistavision size software

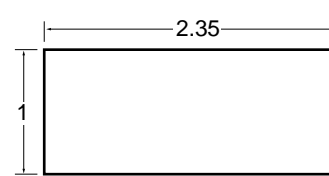

• Cinemavision size software

* Even when ZOOM 1 or ZOOM 2 is set for Vistavision size or Cinemavision size software that is predominantly used for movie software, dark areas may remain at the top and bottom.

Points about usage

- The Plasmavision can be switched to a variety of screen modes. When the selected mode has a different picture aspect ratio from the media to be viewed, the picture will appear different from the original. Keep this in mind when selecting the screen mode.
- Note that use of a wide select function to change the screen size or aspect ratio during commercial use or for public viewing in a coffee shop, hotel, or the like, may infringe on copyrights protected by the copyright law. To respect the intent of the creators of the original video, use NORMAL mode.
- If the wide select function is used to display non-wide screen conventional (normal) 4:3 video software over the entire screen, the picture will be deformed with part of the edge not visible.
- VIDEO mode is the generic term for VIDEO mode, S-VIDEO mode, and COMPONENT VIDEO mode.

VIEWING WIDE SCREEN (RGB MODE)

SETTING THE DESIRED WIDE SCREEN SIZE

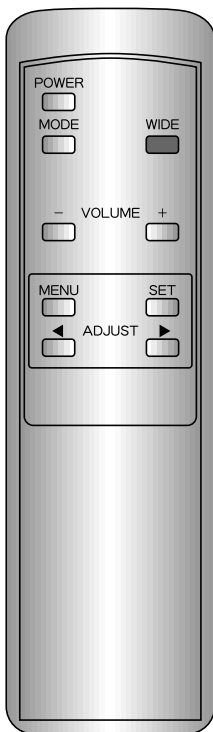

1 Press the WIDE button.

The current viewing mode is displayed.

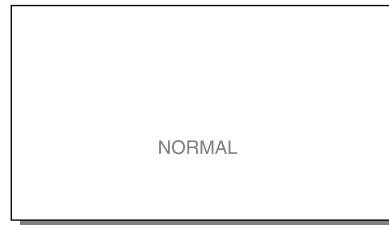

Example: NORMAL

2 Use the WIDE button to select the desired screen size.

Pressing the WIDE button moves the mode to the next item as below.

NORMAL ↔ WIDE



Example: When WIDE is selected

* This operation can also be done using the buttons on the Display's operation panel.

WIDE SCREEN MODES (RGB MODE)

- When the screen is vertically wide

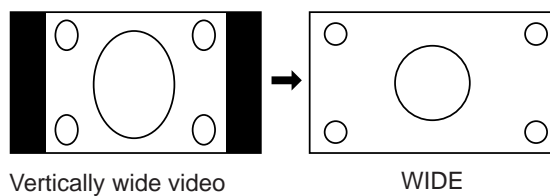

Points about usage

- *Note that use of a wide select function to change the screen size or aspect ratio during commercial use or for public viewing in a coffee shop, hotel, or the like, may infringe on copyrights protected by the copyright law.*
 - *To respect the intent of the creators of the original video, use NORMAL mode.*
-

HANDY FUNCTIONS

ON-SCREEN DISPLAY SETTING

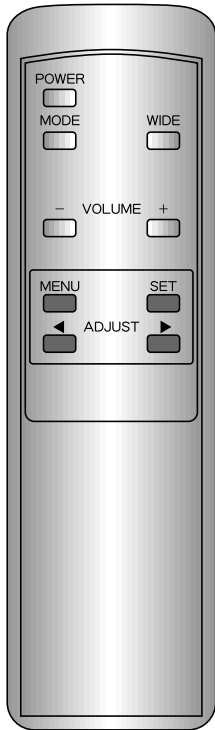

* This operation can also be done using the buttons on the Display's operation panel.

1 Select COMMON SETTINGS from the VIDEO MENU screen.

- 1) Press the MENU button.
- 2) With the ADJUST button, select COMMON SETTINGS.
- 3) Set by pressing the SET button.

COMMON SETTINGS can be set in the same way from any mode menu.

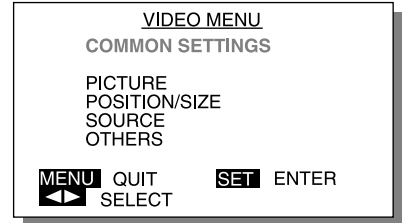

Example: When COMMON SETTINGS is selected

2 Select the adjustment item.

With the SET button, select DISPLAY.

Pressing the SET button moves the selection to the next item as below.

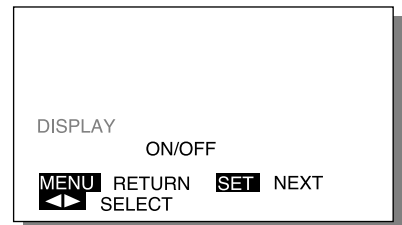
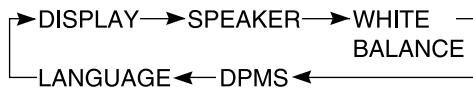

Example: When DISPLAY is selected

3 Set the desired setting.

Pressing the ADJUST button moves the selection to the next item as below.

ON... The mode is displayed on the screen for a few seconds when the power is first switched on and when the mode is switched.

OFF...The mode is not displayed.



Example: When ON is selected

* To complete adjustments

Press the MENU button to return to the VIDEO MENU.

Pressing the MENU button returns the display to the previous screen and closes the adjustment screen.

INTERNAL SPEAKER SETTING

1 Select COMMON SETTINGS from the VIDEO MENU screen.

- 1) Press the MENU button.
- 2) With the ADJUST button, select COMMON SETTINGS.
- 3) Set by pressing the SET button.

COMMON SETTINGS can be set in the same way from any mode menu.

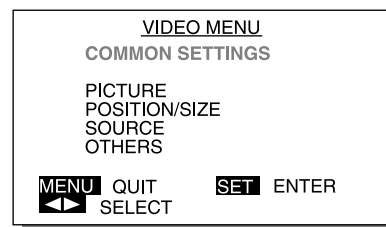

Example: When COMMON SETTINGS is selected

2 Select the adjustment item.

With the SET button, select SPEAKER.

Pressing the SET button moves the selection to the next item as below.

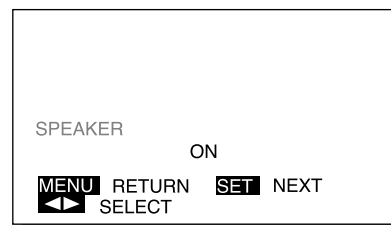
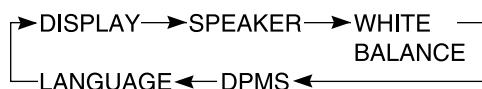

Example: When SPEAKER is selected

3 Set the internal speakers.

Select with the ADJUST button.

Pressing the ADJUST button moves the selection to the next item as below.

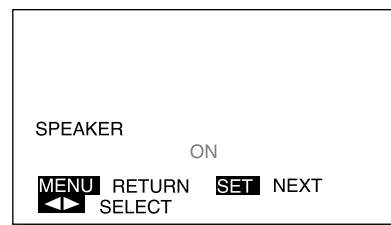
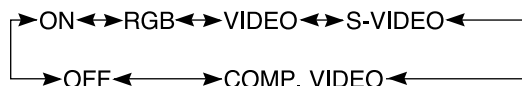

Example: When ON is selected

* To complete adjustments

Press the MENU button to return to the VIDEO MENU.

Pressing the MENU button returns the display to the previous screen and closes the adjustment screen.

Adjustment items

- Pressing the SET button moves the selection to the next item.
- ON: When using the internal speakers regardless of mode
- RGB: When using the internal speakers in RGB mode only
- VIDEO: When using the internal speakers in VIDEO mode only
- S-VIDEO: When using the internal speakers in S-VIDEO mode only
- COMP.VIDEO: When using the internal speakers in COMPONENT VIDEO mode only
- OFF: When not using the internal speakers

If there is no operation for 60 seconds, the screen display goes off.

HANDY FUNCTIONS

WHITE BALANCE SETTING

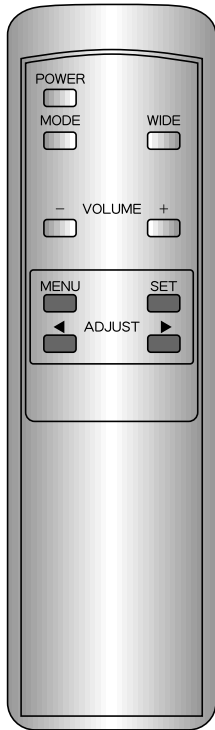

* This operation can also be done using the buttons on the Display's operation panel.

1 Select COMMON SETTINGS from the VIDEO MENU screen.

- 1) Press the MENU button.
- 2) With the ADJUST button, select COMMON SETTINGS.
- 3) Set by pressing the SET button.

COMMON SETTINGS can be set in the same way from any mode menu.

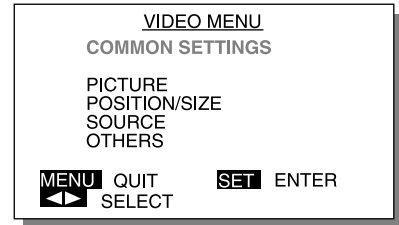

Example: When COMMON SETTINGS is selected

2 Select the adjustment item.

With the SET button, select WHITE BALANCE.

Pressing the SET button moves the selection to the next item as below.

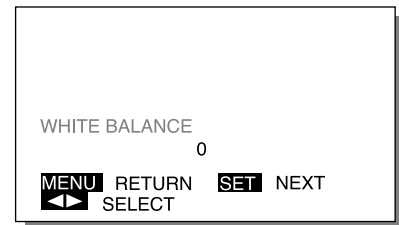

Example: When WHITE BALANCE is selected

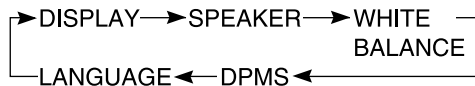

3 Adjust to the desired white balance.

With the ADJUST button, select the desired WHITE BALANCE.

Select the tint with the ADJUST button.

Pressing the ADJUST button moves the selection to the next item as below.

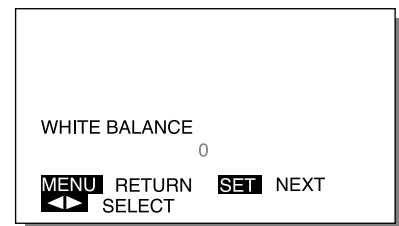

Example: When 0 is selected

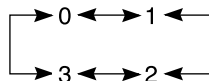

* To complete adjustments

Press the MENU button to return to the VIDEO MENU.

Pressing the MENU button returns the display to the previous screen and closes the adjustment screen.

DPMS AND DISPLAY LANGUAGE SETTING

DPMS SETTING

The time until the power conservation function operates can be set.

Select with the ADJUST button.

Pressing the ADJUST button moves the selection to the next item as below.

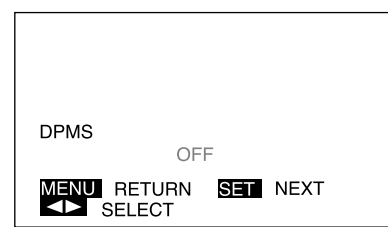

Example: When OFF is selected

LANGUAGE (DISPLAY LANGUAGE) SETTING

The language for the display can be set.

Select with the ADJUST button.

Pressing the ADJUST button moves the selection to the next item as below.

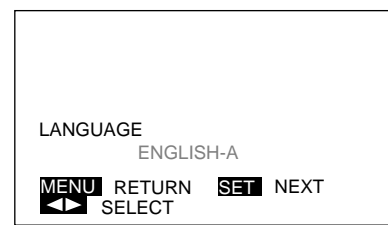
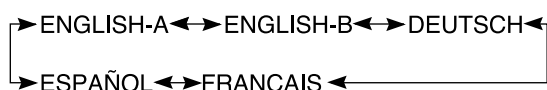

Example: When ENGLISH-A is selected

Note: The setting title and guidance display also change.

Setting titles

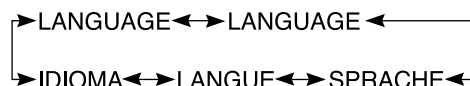

Adjustment items

- An adjustment item is selected each time the SET button is pressed.

DPMS

DPMS stands for Display Power Management Signaling. It is a function that automatically reduces the amount of power consumed by the monitor.

When the power is on, if no signal is input within the set time, the power management function is triggered, the monitor screen is automatically switched off, and the monitor goes on standby.

This signal wait time can be set from 1 to 5 minutes in units of one minute. Also, the power management function can be switched off. (The factory setting is OFF.)

This display has a five-language on screen menu.

- ENGLISH-A ----- American English
- ENGLISH-B ----- British English
- DEUTSCH ----- German
- FRANÇAIS ----- French
- ESPAÑOL ----- Spanish

If there is no operation for 60 seconds, the screen display goes off.

VIDEO ADJUSTMENTS (VIDEO MODE)

EXAMPLE: ADJUSTING THE BRIGHTNESS

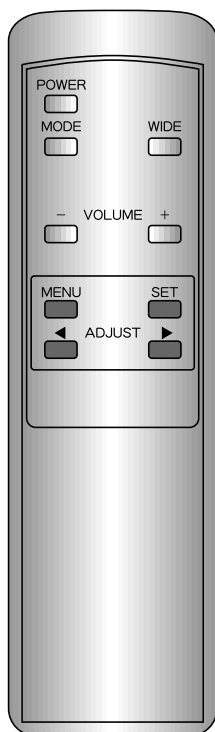

* This operation can also be done using the buttons on the Display's operation panel.

1 Select PICTURE from the VIDEO MENU screen.

- 1) Press the MENU button.
- 2) With the ADJUST button, select PICTURE.
- 3) Set by pressing the SET button.

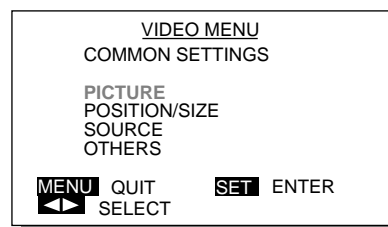

Example: When PICTURE is selected

2 Select the adjustment item.

With the SET button, select BRIGHTNESS.

Pressing the SET button moves the selection to the next item as below.

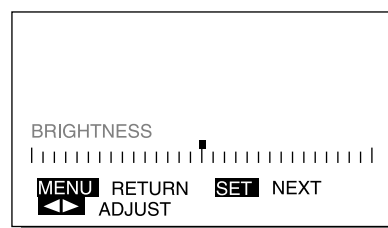

Example: When BRIGHTNESS is selected

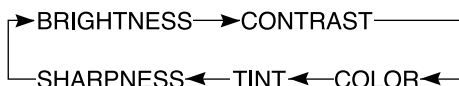

3 Adjust to the desired picture.

▶ button....Makes the picture brighter.

◀ button....Makes the picture darker.

* To adjust multiple items, repeat Steps 2 and 3.

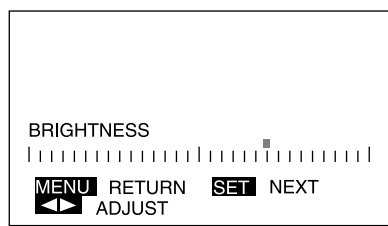

Example: When the ▶ button is pressed

* To complete adjustments

Press the MENU button to return to the VIDEO MENU.

Pressing the MENU button returns the display to the previous screen and closes the adjustment screen.

* The adjustments are saved for each video mode (VIDEO mode, S-VIDEO mode, and COMPONENT VIDEO mode).

VIDEO ADJUSTMENT ITEMS

BRIGHTNESS

Screen brightness can be adjusted.

- ▶ button: Makes the picture brighter.
- ◀ button: Makes the picture darker.



CONTRAST

Screen contrast (difference between dark and light) can be adjusted.

- ▶ button: Makes the contrast stronger.
- ◀ button: Makes the contrast weaker.

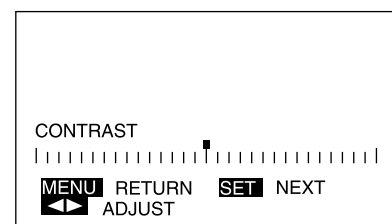

COLOR (color saturation)

Color saturation can be adjusted.

- ▶ button: Makes the color more saturated.
- ◀ button: Makes the color less saturated.

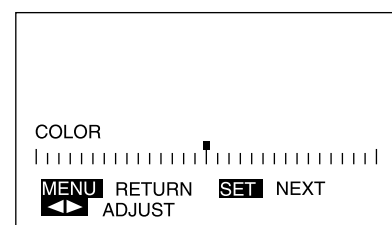

TINT

Color tint can be adjusted.

- ▶ button: Makes the tint greener.
- ◀ button: Makes the tint more purple.

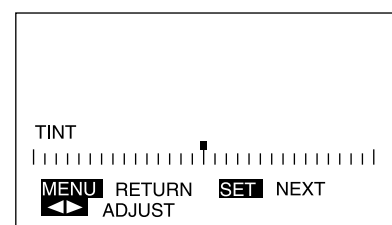

SHARPNESS

Picture sharpness can be adjusted.

- ▶ button: Makes a sharper picture.
- ◀ button: Makes a softer picture.

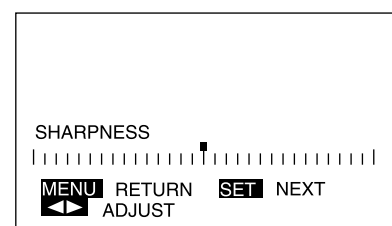

Adjustment items

- Pressing the SET button moves selection to the next item.
- VIDEO mode is the generic term for VIDEO mode, S-VIDEO mode, and COMPONENT VIDEO mode.
- The adjustments are saved for each video mode.
- TINT functions only in NTSC mode.

If there is no operation for 60 seconds, the screen display goes off.

SCREEN ADJUSTMENT (VIDEO MODE)

EXAMPLE: ADJUSTING THE SCREEN VERTICAL POSITION

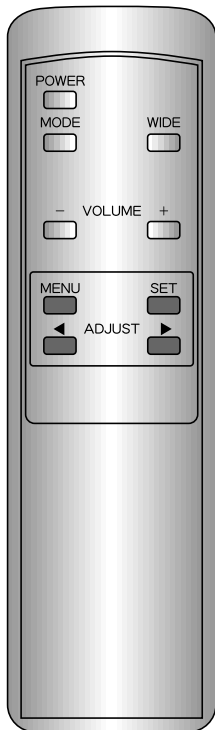

1 Select POSITION/SIZE from the VIDEO MENU screen.

- 1) Press the MENU button.
- 2) With the ADJUST button, select POSITION/SIZE.
- 3) Set by pressing the SET button.

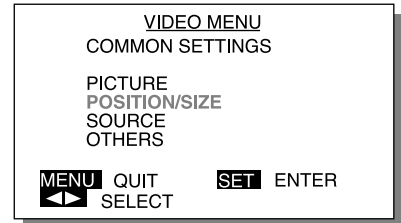

Example: When POSITION/SIZE is selected

2 Select the adjustment item.

With the SET button, select VERTICAL POSITION.

Pressing the SET button moves the selection to the next item as below.

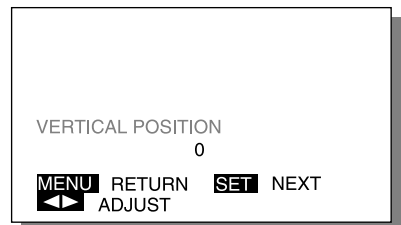

Example: When VERTICAL POSITION is selected

* This operation can also be done using the buttons on the Display's operation panel.

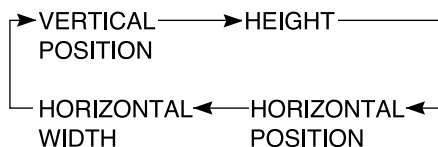

3 Adjust with the ADJUST button.

- ▶ button....Moves the screen up.
- ◀ button....Moves the screen down.

For the adjustment range, see the opposite page.

To adjust multiple items, repeat steps 2 and 3.

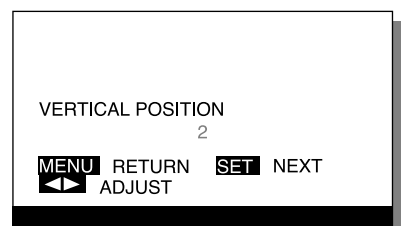

Example: When the ▶ button is pressed

* To complete adjustments

Press the MENU button to return to the VIDEO MENU.

Pressing the MENU button returns the display to the previous screen and closes the adjustment screen.

* The adjustments are saved for each video mode (VIDEO mode, S-VIDEO mode, and COMPONENT VIDEO mode).

ADJUSTMENT ITEM LIST (ADJUSTMENT CRITERIA)

VERTICAL POSITION



When too low....Adjust with the ► button.



When too high....Adjust with the ◀ button.

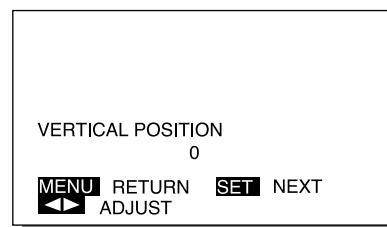

HEIGHT

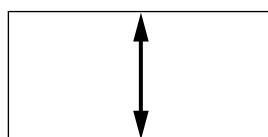

When too small....Adjust with the ► button.



When too large....Adjust with the ◀ button.

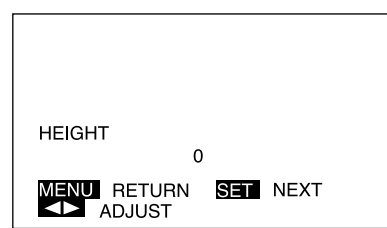

HORIZONTAL POSITION



When too far left:....Adjust with the ► button.



When too far right:....Adjust with the ◀ button.

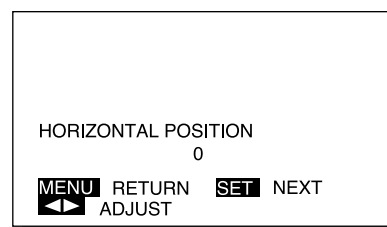

HORIZONTAL WIDTH

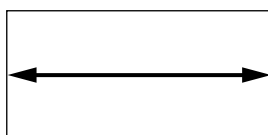

When too small....Adjust with the ► button.



When too large....Adjust with the ◀ button.

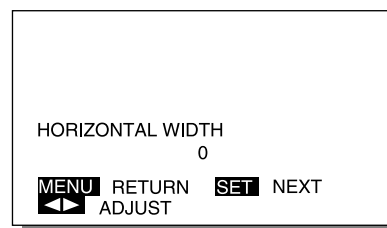

Adjustment items

- Pressing the SET button moves selection to the next item.

VERTICAL POSITION

- For VIDEO and S-VIDEO modes: ZOOM: -15 through +15 Other: -7 through +7
- COMPONENT VIDEO mode: -90 through +90

HEIGHT

- For VIDEO and S-VIDEO modes: -7 through +7 COMPONENT VIDEO mode: -70 through +70

HORIZONTAL POSITION

- For VIDEO and S-VIDEO modes: -31 through +31 COMPONENT VIDEO mode: -90 through +90

HORIZONTAL WIDTH

- For all modes: -7 through +7
- VIDEO mode is the generic term for VIDEO mode, S-VIDEO mode, and COMPONENT VIDEO mode.
- The adjustments are saved for each video mode.

If there is no operation for 60 seconds, the screen display goes off.

INPUT SOURCE ADJUSTMENTS (VIDEO MODE)

EXAMPLE: SETTING COMPONENT VIDEO

Setting must be done when connecting a color difference signal to the COMPONENT VIDEO terminal.

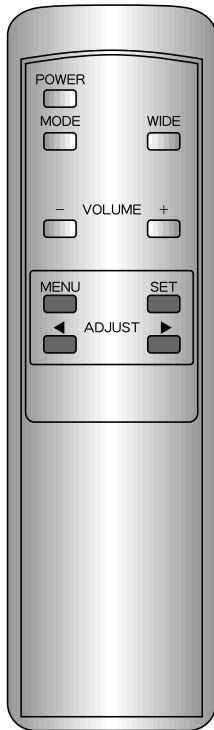

* This operation can also be done using the buttons on the Display's operation panel.

1 Select SOURCE from the VIDEO MENU screen.

- 1) In COMPONENT VIDEO mode, press the MENU button.
 - 2) With the ADJUST button, select SOURCE.
 - 3) Set by pressing the SET button.
- * This setting can be done in COMPONENT VIDEO mode only.

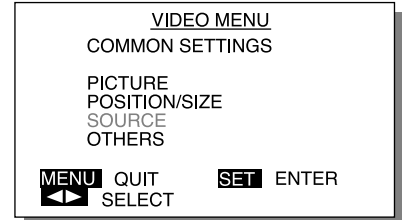

Example: When SOURCE is selected

2 Select the adjustment item.

With the SET button, select COMPONENT VIDEO.
Pressing the SET button moves the selection to the next item as below.

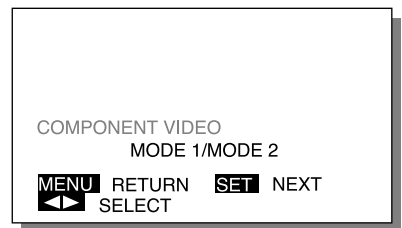

Example: When COMPONENT VIDEO is selected

COMPONENT VIDEO ↔ CLAMP PULSE

* COMPONENT VIDEO and CLAMP PULSE are set for COMPONENT VIDEO mode. VIDEO SYSTEM can be set for VIDEO mode and S-VIDEO mode.

3 Set the connected equipment.

Select with the ADJUST button.
MODE 1: Use this mode for normal usage such as DVD, BETACAM or other standard component video signals.
MODE 2: Use this mode only for MUSE signal (Hi-Vision – Japanese high definition video signal).

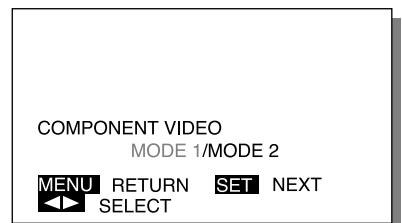

Example: When MODE 1 is selected

* To complete adjustments

Press the MENU button to return to the VIDEO MENU.

Pressing the MENU button returns the display to the previous screen and closes the adjustment screen.

* COMPONENT VIDEO and CLAMP PULSE can be set in COMPONENT VIDEO mode only. VIDEO SYSTEM can be set in VIDEO mode and S-VIDEO mode only.

SETTING VIDEO SYSTEM AND CLAMP PULSE

VIDEO SYSTEM

VIDEO SYSTEM can be set when the signal is connected to the VIDEO or S-VIDEO input terminal.

Set by adjusting to the connected signal.

In VIDEO or S-VIDEO mode, press the MENU button to select SOURCE.

Select with the ADJUST button.

Pressing the ADJUST button moves the selection to the next item as below.

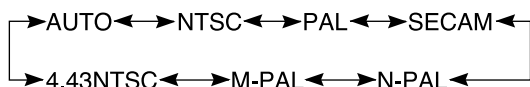

* When N-PAL and M-PAL signals are input, signals cannot be received successfully in AUTO mode. Select either N-PAL or M-PAL.

* This setting can be done in VIDEO mode and S-VIDEO mode only. The VIDEO SYSTEM setting is saved for VIDEO mode and S-VIDEO mode.

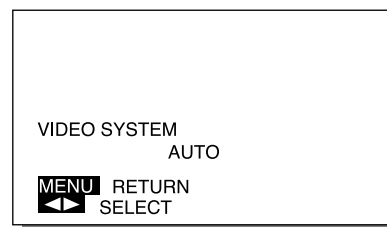

CLAMP PULSE

When connecting a color difference signal to the COMPONENT VIDEO input terminal, CLAMP PULSE must be set.

This setting switches the phase of the clamp pulse.

The ADJUST button can be adjusted in the range from 0 through 4.

Select so the optimum picture is attained.

* This setting can be done in COMPONENT VIDEO mode only.

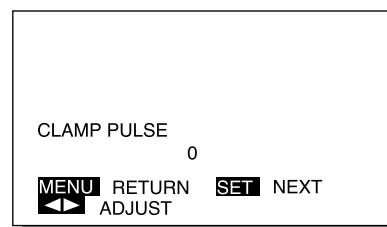

Adjustment items

- Pressing the SET button moves selection to the next item.
- Set CLAMP PULSE as follows, depending on the connected device signal.

1 : MUSE signal (Hi-Vision – Japanese high definition video signal)

4: NTSC, PAL, SECAM

When connecting the other devices than the ones described above, adjust the clamp pulse so that the optimum image is obtained.

If there is no operation for 60 seconds, the screen display goes off.

OTHER ADJUSTMENTS (VIDEO MODE)

EXAMPLE: MAKING THE GAMMA SETTING

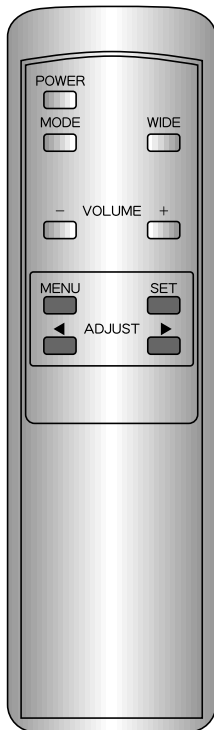

1 Select OTHERS from the VIDEO MENU screen.

- 1) Press the MENU button.
- 2) With the ADJUST button, select OTHERS.
- 3) Press the SET button to fix the OTHER setting.

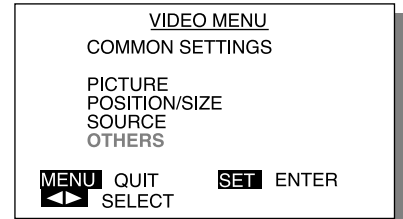

Example: When OTHERS is selected

2 Select the adjustment item.

With the SET button, select GAMMA.

Pressing the SET button moves the selection to the next item as below.

GAMMA ↔ GRADATION

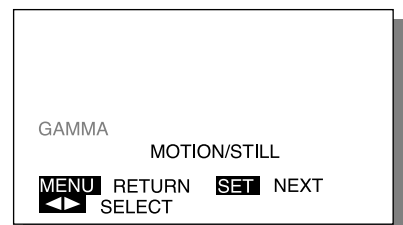

Example: When GAMMA is selected

* This operation can also be done using the buttons on the Display's operation panel.

3 Select the desired picture.

Select with the ADJUST button.

MOTION

Carries out automatic correction so that the video is optimum for viewing moving images.

STILL

Carries out automatic correction so that the video is optimum for viewing still images.

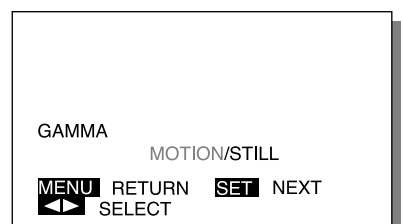

Example: When MOTION is selected

* To complete adjustments

Press the MENU button to return to VIDEO MENU.

Pressing the MENU button returns the display to the previous screen and closes the adjustment screen.

* The adjustments are saved for each video mode (VIDEO mode, S-VIDEO mode, and COMPONENT VIDEO mode).

OTHER ADJUSTMENT ITEMS

GRADATION

Gradation display can be selected to suit still or moving images.

MODE1.... Carries out automatic correction so that the video is optimum for viewing moving images.

MODE2.... Carries out automatic correction so that the video is optimum for viewing still images.

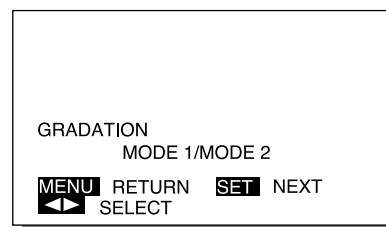

Adjustment items

- Pressing the *SET* button moves selection to the next item.
- *VIDEO* mode is the generic term for *VIDEO* mode, *S-VIDEO* mode, and *COMPONENT VIDEO* mode.
- The adjustments are saved for each video mode.

If there is no operation for 60 seconds, the screen display goes off.

VIDEO ADJUSTMENTS (RGB MODE)

EXAMPLE: ADJUSTING THE CONTRAST

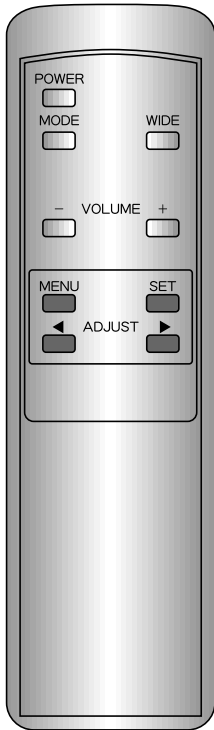

1 Select PICTURE from the RGB MENU screen.

- 1) Press the MENU button.
- 2) With the ADJUST button, select PICTURE.
- 3) Set by pressing the SET button.

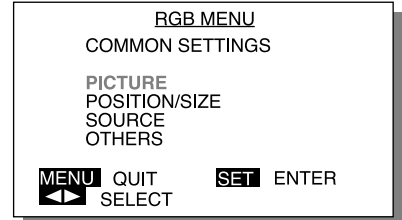

Example: When PICTURE is selected

2 Select the adjustment item.

With the SET button, select CONTRAST.

Pressing the SET button moves the selection to the next item as below.

BRIGHTNESS ↔ CONTRAST

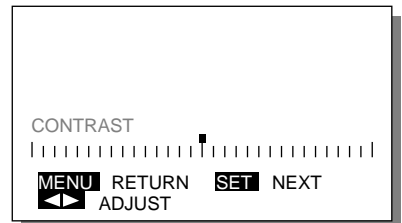

Example: When CONTRAST is selected

* This operation can also be done using the buttons on the Display's operation panel.

3 Adjust to the desired picture.

▶ button....Makes the contrast stronger.

◀ button....Makes the contrast weaker.

To adjust another item, repeat steps 2 and 3.

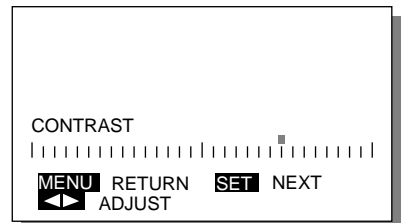

Example: When the ▶ button is pressed

* To complete adjustments

Press the MENU button to return to the RGB MENU.

Pressing the MENU button returns the display to the previous screen and closes the adjustment screen.

VIDEO ADJUSTMENT ITEMS

BRIGHTNESS

Screen brightness can be adjusted.

▶ button: Makes the picture brighter.

◀ button: Makes the picture darker.

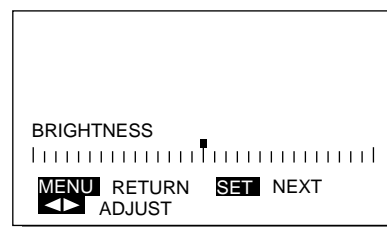

CONTRAST

Screen contrast (difference between dark and light) can be adjusted.

▶ button: Makes the contrast stronger.

◀ button: Makes the contrast weaker.

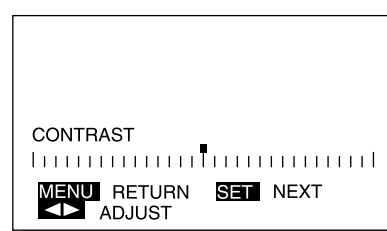

Adjustment items

- Pressing the SET button moves the selection to the next item.

If there is no operation for 60 seconds, the screen display goes off.

SCREEN ADJUSTMENT (RGB MODE)

EXAMPLE: ADJUSTING THE HEIGHT OF THE SCREEN

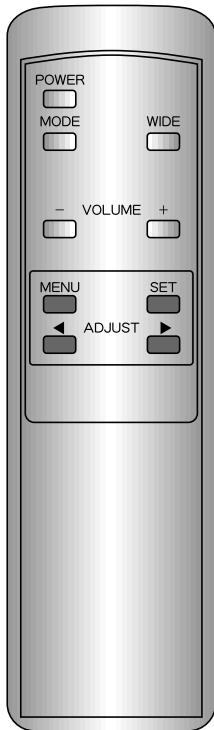

* This operation can also be done using the buttons on the Display's operation panel.

1 Select POSITION/SIZE from the RGB MENU screen.

- 1) Press the MENU button.
- 2) With the ADJUST button, select POSITION/SIZE.
- 3) Set by pressing the SET button.

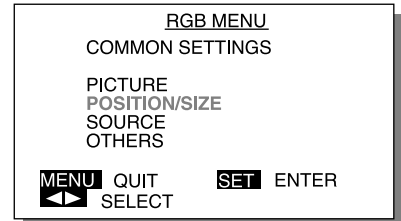

Example: When POSITION/SIZE is selected

2 Select the adjustment item.

With the SET button, select HEIGHT.

Pressing the SET button moves the selection to the next item as below.

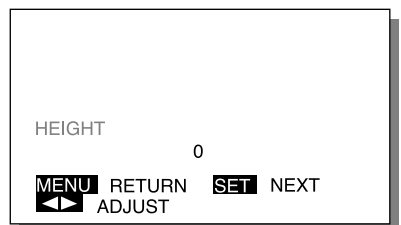

Example: When HEIGHT is selected

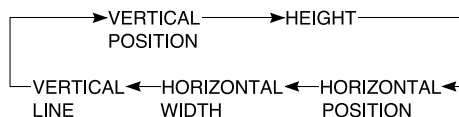

3 Adjust with the ADJUST button.

- ▶ button....Enlarges the screen.
- ◀ button....Reduces the screen.

The adjustment range is from -150 through +150.

To adjust multiple items, repeat steps 2 and 3.



Example: When the ◀ button is pressed

* To complete adjustments

Press the MENU button to return to the RGB MENU.

Pressing the MENU button returns the display to the previous screen and closes the adjustment screen.

ADJUSTMENT ITEM LIST (ADJUSTMENT CRITERIA)

VERTICAL POSITION

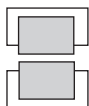

When too low...Adjust with the ► button.
 When too high...Adjust with the ◀ button.
 The adjustment range is from -250 through +250.

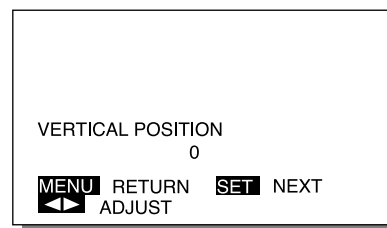

HEIGHT

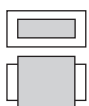
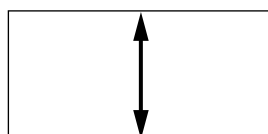

When too small...Adjust with the ► button.
 When too large...Adjust with the ◀ button.
 The adjustment range is from -150 through +150.

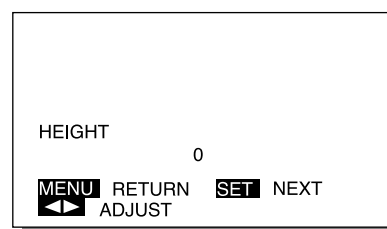

HORIZONTAL POSITION



When too far left...Adjust with the ► button.
 When too far right...Adjust with the ◀ button.
 The adjustment range is from -250 through +250.

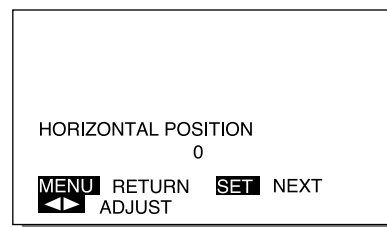

HORIZONTAL WIDTH

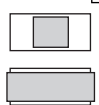
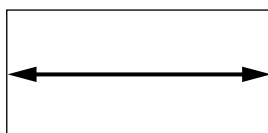

When too small...Adjust with the ► button.
 When too large...Adjust with the ◀ button.
 The adjustment range is from -150 through +150.

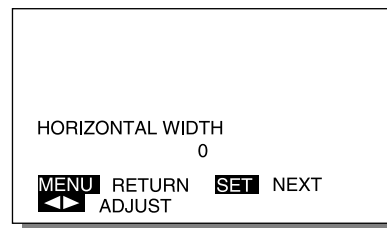

VERTICAL LINE

The number of vertical lines on the screen can be set.
 With the ADJUST button, select the number of vertical lines.
 Pressing the ADJUST button moves the selection to the next item as below.

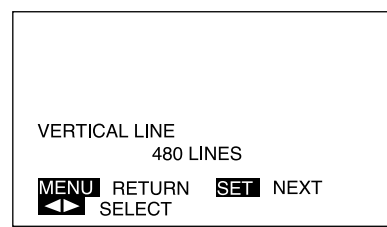
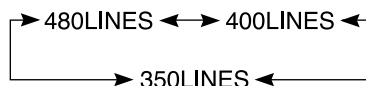

Adjustment items

- Pressing the SET button moves selection to the next item.
- After adjustment, the screen may be jumbled. If so, return the setting to the original adjustment value.

If there is no operation for 60 seconds, the screen display goes off.

INPUT SOURCE ADJUSTMENTS (RGB MODE)

The Macintosh mode and the clamp pulse mode can be set for the input source, and the input signal can be confirmed.

EXAMPLE: SETTING MACINTOSH MODE

The Apple Macintosh has two dot clocks. If the display is partly cut or the video and the dot clock do not match, set the dot clock as follows:

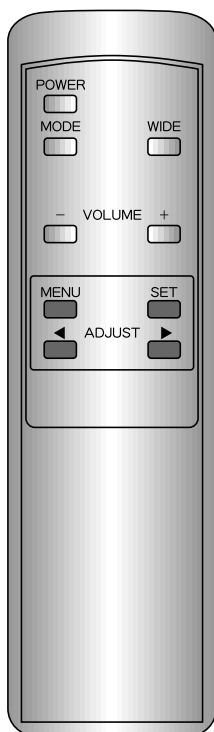

1 Select SOURCE from the RGB MENU screen.

- 1) Press the MENU button.
- 2) With the ADJUST button, select SOURCE.
- 3) Set by pressing the SET button.

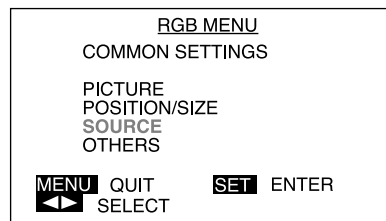

Example: When SOURCE is selected

2 Select the adjustment item.

With the SET button, select MAC MODE.

Pressing the SET button moves the selection to the next item as below.

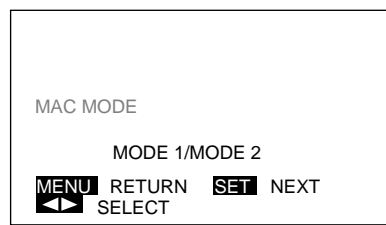
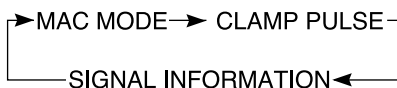

Example: When MAC MODE is selected

* This operation can also be done using the buttons on the Display's operation panel.

3 Select the appropriate mode for the dot clock.

Select with the ADJUST button.

Pressing the ADJUST button moves the selection to the next item as below.

MODE 1 ↔ MODE 2

f_H f_V

MODE 1...35 kHz 66.67 Hz

MODE 2...34.975 kHz 66.61 Hz

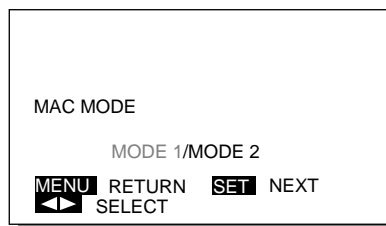

Example: When MODE1 is selected

To adjust multiple items, repeat steps 2 and 3.

* To complete adjustments

Press the MENU button to return to the RGB MENU.

Pressing the MENU button returns the display to the previous screen and closes the adjustment screen.

OTHER ADJUSTMENTS AND CHECK ITEMS

CLAMP PULSE

CLAMP PULSE must be set when the signal is connected to the RGB input terminal.

This setting switches the phase of the clamp pulse.

The ADJUST button can be adjusted in the range from 0 through 4.

Select so tha optimum picture is attained.

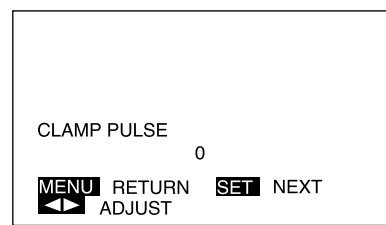

SIGNAL INFORMATION

The sync signal information input from the RGB input terminal can be checked.

MODE: Fixed mode No. (Mode Nos. are set out on page 40.)

TYPE: COMPOSITE, SEPARATE or SYNC ON GREEN.

* For details, see "Personal Computers that Can Be Connected" on page 40.

* When no signal is detected, **NO SIGNAL** is displayed.

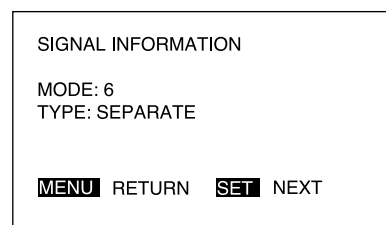

Adjustment items

- Pressing the SET button moves selection to the next item.
- Set CLAMP PULSE as follows, depending on the connected device signal.
 - 0 : Normal
 - 1 : MUSE signal (Hi-Vision – Japanese high definition video signal)
 - 2 : Other
 - 3 : MAC
 - 4 : NTSC, PAL, SECAM

Points about usage

Depending on the type of device inputting the signal, SYNC ON GREEN and other sync signals may be input simultaneously. This can cause the background of the screen to be too bright or too green. If this occurs, set the clamp pulse to 3.

If there is no operation for 60 seconds, the screen display goes off.

OTHER ADJUSTMENTS (RGB MODE)

EXAMPLE: SETTING THE GRADATION

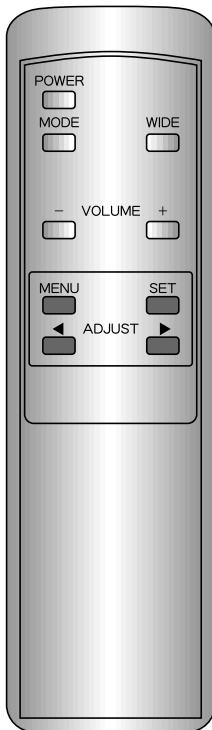

1 Select OTHERS from the RGB MENU screen.

- 1) Press the MENU button.
- 2) With the ADJUST button, select OTHERS.
- 3) Set by pressing the SET button.

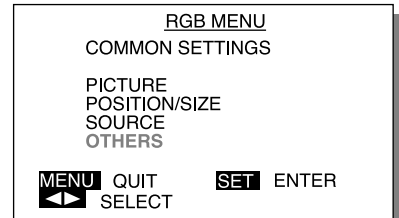

Example: When OTHERS is selected

2 Select the adjustment item.

With the SET button, select GRADATION.

Pressing the SET button moves the selection to the next item as below.

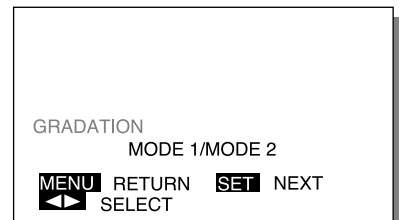
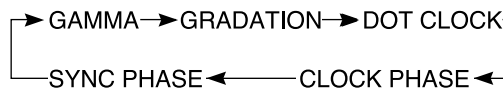

Example: When GRADATION is selected

* This operation can also be done using the buttons on the Display's operation panel.

3 Adjust to the desired picture.

Select with the ADJUST button.

MODE1: Carries out automatic correction so that the video is optimum for viewing moving images.

MODE2: Carries out automatic correction so that the video is optimum for viewing still images.

* To adjust multiple items, repeat steps 2 and 3.

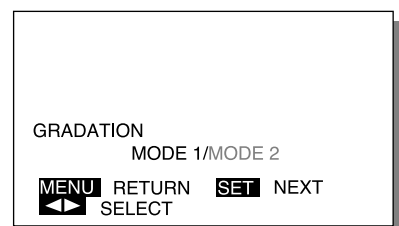

Example: When the MODE 2 is selected

* To complete adjustments

Press the MENU button to return to the RGB MENU.

Pressing the MENU button returns the display to the previous screen and closes the adjustment screen.

OTHER ADJUSTMENT ITEMS (ADJUSTMENT CRITERIA)

GAMMA

Dynamic GAMMA correction can be set.

MOTION: Set for viewing moving images.

STILL: Set for viewing still images.

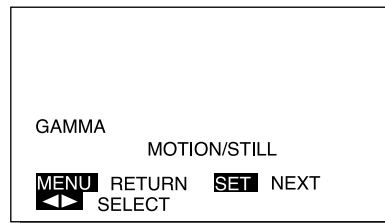

GRADATION

Gradation can be set.

MODE 1: Set for viewing moving images.

MODE 2: Set for viewing still images.

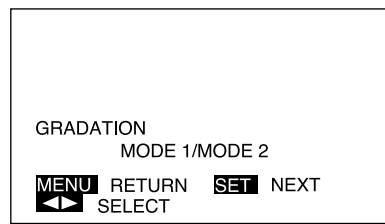

DOT CLOCK

Depending on the clock frequency of the personal computer, the screen may become blurred. If so, adjust.

The ADJUST button can be adjusted in the range from -300 through +300.

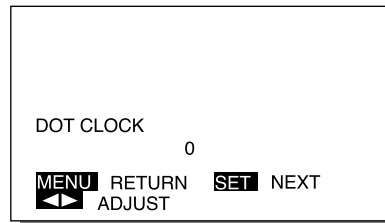

CLOCK PHASE

Depending on the clock phase of the personal computer, the screen may become blurred. If so, adjust.

The ADJUST button can be adjusted in the range from 0 through 15.

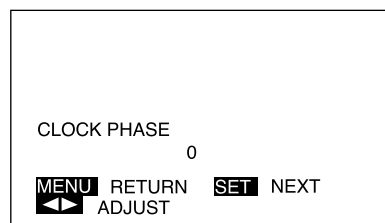

SYNC PHASE

The screen may tremble vertically. If so, use the ADJUST button to adjust the screen within the range of -2 and +1.

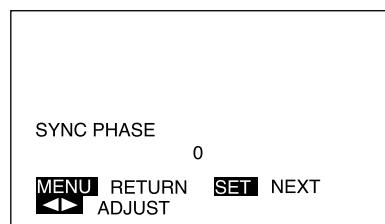

Adjustment items

- Pressing the SET button moves selection to the next item.
- When GRADATION is automatically recognized in SVGA mode, it cannot be set.
- Adjust DOT CLOCK and CLOCK PHASE after invoking normal mode with the WIDE button.
- When SVGA mode has been automatically recognized, the screen may be jumbled depending on what equipment is connected. If so, adjust DOT CLOCK.

If there is no operation for 60 seconds, the screen display goes off.

PERSONAL COMPUTERS THAT CAN BE CONNECTED

The Plasmavision is set at the factory with adjustment values for 11 types of signals. (See the table below.) When any of these signals is input, it is automatically discriminated. For these signals, the desired screen can be adjusted according to the instructions on adjusting the screen.

The Plasmavision can also store settings for five types of signals in addition to those set at the factory, as shown in the table below. Input the signals whose settings are to be stored into memory and adjust for the desired screen following the instructions on adjusting the screen. Release the adjustment button to automatically store the level into memory. After adjustment, when the same signals are input, they are displayed with the setting levels last stored into memory.

Factory-set signals

Mode number	Display (dots × lines)	Horizontal frequency (kHz)	Vertical frequency (Hz)	Supported signal
1	852 × 480	31.72	59.97	Note1 When dedicated graphics board used
2	640 × 480	31.47	59.94	VGA
3	640 × 480	37.86	72.81	VGA 72 Hz
4	640 × 480	37.50	75.00	VGA 75 Hz
5	720 × 400	31.47	70.09	VGA 400 lines
6	640 × 480	34.97	66.61	MAC 13RGB (1)
	640 × 480	35.00	66.67	MAC 13RGB (2)
7	640 × 400	24.83	56.42	PC98 24kHz
8	640 × 400	31.50	70.15	PC98 31kHz
9	800 × 600	35.16	56.25	SVGA 56 Hz Note2
10	640 × 480	15.73	59.94	60 fields
11	640 × 480	15.63	50.00	50 fields
12				
13				
14		15.63 to 60.00	50.00 to 75.00	User settings
15				
16				

Note 1: The dedicated graphics board is an optional product.

2: The 800 x 600 is compressed display through compression interpolation. Also, the screen display is also compressed for display.

Points about usage

The company names and product names in this document are trademarks or registered trademarks of their respective companies.

The mode numbers indicate the SIGNAL INFORMATION modes set for the RGB mode and input source.

OPTIONAL PRODUCTS

• Wall-mounting unit (horizontal)	For 0° installation angle	P-42WB01-B
	For 5° installation angle	P-42WB02-B
	For 10° installation angle	P-42WB03-B
	For 15° installation angle	P-42WB04-B
• Wall-mounting unit (vertical)	For 0° installation angle	P-42WB50-B
• Ceiling-mounting unit	Installation angle variable 0–15°	P-42CT01-B
	The pipe is not supplied with the ceiling-hanging unit, so consult your product dealer.	
• Desktop stand		P-42TT01-H
• Graphics board	When a graphics board is used with a DOS/V personal computer, an 852 dot x 480 line wide screen can be displayed.	P-42GA04
• AV terminal unit	This is a dedicated PDS4203E-H AV terminal unit. Before attaching, pull out the power plug.	P-42TE01-B

* **When installing an optional product, follow the directions in the optional product user's or installation manual. The colors of the Plasmavision and optional products are slightly different.**

 **WARNING**

- Request your product dealer to mount and install these products.
If you do the mounting or moving work yourself, the equipment may fall or topple over, resulting in injuries, fire, or electrocution.

SPECIFICATIONS

Model name	PDS4203W-H/PDS4203E-H		
Screen size	42 inches---92.0 cm (W) x 51.8 cm (H) x 105.6 cm (width across corners)		
Aspect ratio	16:9		
Weight	38.5 kg		
External dimensions	103.5 (W) × 64.0 (H) × 15.0 (D) cm		
Power supply	100–240VAC, 50/60 Hz		
Power consumption	3.5 A		
Screen dimensions	92.0 (W) x 51.8 (H) cm		
Display pixel count	852 (horizontal) x 480 (vertical)		
Display modes	<ul style="list-style-type: none"> • For video, S-video input: NORMAL, AUTO, WIDE 1, WIDE 2, ZOOM 1, ZOOM 2 • For component video input: NORMAL, WIDE 1, WIDE 2, ZOOM 1, ZOOM 2 • For RGB input: NORMAL, WIDE 		
Display color count	16.77 million (256 each for red, green and blue)		
Audio output	2 W + 2 W (EIAJ)		
Speakers	Two internal		
External connection terminals			
Video	<ul style="list-style-type: none"> • Video input • S video input • Component video input 	One BNC terminal One S terminal Three BNC terminals	1Vp-p/75 Ω Y: 1Vp-p/75 Ω C: 0.286Vp-p/75 Ω Y: 1Vp-p/75 Ω Pb/B-Y: 0.7Vp-p/75 Ω Pr/R-Y: 0.7Vp-p/75 Ω
Compatible format	<ul style="list-style-type: none"> • NTSC, PAL, SECAM, N-PAL, M-PAL, 4.43NTSC 		
PC	<ul style="list-style-type: none"> • RGB input 	One 15-pin 3-row mD-sub terminal Video signal: 0.7Vp-p/75 Ω SYNC signal: TTL level or 0.3Vp-p/75 Ω	
Audio	<ul style="list-style-type: none"> • Audio input 	One system with two pin plug terminals (L/R) 500 mVrms/22 kΩ min.	
Control	<ul style="list-style-type: none"> • RS-232C 	One D-sub 9-pin terminal	
Operating conditions	Temperature: 0 to 40°C Humidity: 20 to 90 %		
Accessories	Two cable claspers, power cord (PDS4203W-H × 3, PDS4203E-H × 1), one remote controller (P-42RM01-B), two AA batteries, one user's manual, two brackets (two types), two screws (two types)		

- Specifications and external appearance may be changed for the sake of improvement.

RGB input terminal (Display is RGB INPUT.)

Connects to a personal computer RGB output terminal.

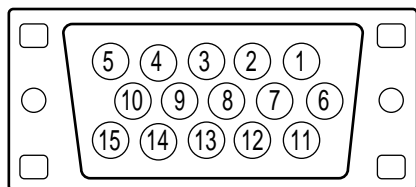

* The sync switch (TTL/ANALOG switch) is on the rear of the 13-pin horizontal sync and 14-pin vertical sync terminals.

Pin No.	Input signal	Pin No.	Input signal
1	Red	9	
2	Green	10	Ground
3	Blue	11	
4		12	
5	Ground	13	Hor. sync
6	Ground	14	Vert. sync
7	Ground	15	
8	Ground	Outer side	Ground

RS-232C input terminal (Display is RS-232C.)

Connects to a personal computer RS-232C terminal.

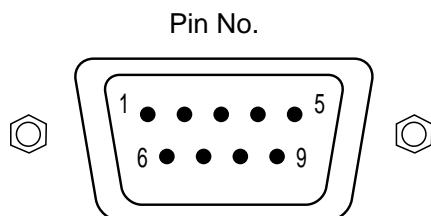

Pin No.	No. Signal
1	DCD (Data Carrier Detect)
2	RD (Receive Data)
3	TD (Transmit Data)
4	DTR (Data Terminal Ready)
5	GND (Ground)
6	DSR (Data Set Ready)
7	RTS (Request To Send)
8	CTS (Clear To Send)
9	RI (Ring Indication)

Regulation---PDS4203W-H/PDS4203E-H

- UL, CSA Safety: UL1950/CSA C22.2 No.950/FCC Class
EMC: FCC Part 15 Class A
- CE Safety: EN60950 1992A1: 1993/A2: 1993
EMC: EN55022 1994, Class A
EN61000-3-2 1995
EN61000-3-3 1995
EN50082-2 1995
(EN61000-4-2 1995)
(EN61000-4-4 1995)
(EN61000-4-8 1993)
(ENV50140 1993)
(ENV50141 1993)
(ENV50204 1995)
- AS Safety: IEC950 A1/A2/A3/A4
EMC: AS/NZS 3548

Points about shipping

The Plasmavision is a precision instrument, and requires dedicated packing materials for shipping.

* Use Fujitsu's packing materials only.

CARE AND MAINTENANCE

BEFORE CLEANING

Always unplug the power cord from the socket.

Cleaning the cabinet and remote controller

Do not use benzene, paint thinner, or other solvents. They can cause deterioration or paint peeling on the cabinet, the screen front filter, or the remote controller.

Wipe gently with a soft cloth.

For stubborn grime, soak the soft cloth in neutral cleaning agent diluted with water, wring it out well, and wipe clean. Then, finish with a dry, soft cloth.

Cleaning the screen

Wipe gently with a soft cloth.

The surface of the screen is easily scratched, so do not strike it or rub it with anything hard.

BEFORE REQUESTING REPAIR

If you think a malfunction may have occurred, check the following items.

When this happens	Check
<ul style="list-style-type: none"> The power does not come on. 	<ul style="list-style-type: none"> Is the power cord disconnected?
<ul style="list-style-type: none"> The picture dose not appear. 	<ul style="list-style-type: none"> Is a cable to other equipment disconnected?
<ul style="list-style-type: none"> The remote controller does not work. 	<ul style="list-style-type: none"> Are the batteries installed with their poles reversed? Are the batteries flat? Are you operating from far away? Are you trying to operate with the transmitting section of the remote controller not facing the reception section of the display? Is there any obstruction between the display and the remote controller?
<ul style="list-style-type: none"> There is a creaking sound. 	<ul style="list-style-type: none"> This sound is generated by the expansion and contraction of the cabinet owing to change in the room temperature.
<ul style="list-style-type: none"> There is a humming sound. 	<ul style="list-style-type: none"> The Plasmavision has heat radiation fins to prevent its internal temperature from rising too high during operation. The sound you hear is the fan rotating.
<ul style="list-style-type: none"> There are dots on the screen. 	<ul style="list-style-type: none"> Is the connected tuner being affected by interference from a car, train, high-voltage line, neon light, or the like?
<ul style="list-style-type: none"> The colors and tints are not good. 	<ul style="list-style-type: none"> Do any of the video settings need readjusting?
<ul style="list-style-type: none"> There is no sound. 	<ul style="list-style-type: none"> Are the internal speakers switched off?
<ul style="list-style-type: none"> ERROR MESSAGE CONDITION 1 is displayed. 	<ul style="list-style-type: none"> The fan is malfunctioning. Switch off the power.
<ul style="list-style-type: none"> ERROR MESSAGE CONDITION 2 is displayed. 	<ul style="list-style-type: none"> The temperature inside the set has risen far too high. Switch off the power. (The power can be turned on once the temperature lowers.)